



USA
Instructions for use **EN**
(IMMI)

PRIMO VIAGGIO SIP ES 30-30

Integrated Side Impact Protection

OWNER'S MANUAL

⚠ WARNING:

Do not install or use this infant restraint until you read and understand all instructions in this manual. To avoid serious injuries to your baby, follow the instructions carefully and be sure to buckle your baby using the 5-point harness.

Child Requirements:

Weight limits: 30 pounds (13,5 kg)

Maximum height: 30 inches (76 cm)

FIUS10011106



Table of Contents

- | | | | |
|-----------|--|-----------|--|
| 3 | Before You Start | 23 | Installing the Car Seat on the Base |
| 4 | Customer Service | 25 | Installing the Car Seat without the Base |
| 4 | Registration Form | 27 | Installing the Seat with Different Types of Seat Belts |
| 5 | Safety | 28 | How to Buckle Your Baby into the Car Seat |
| 7 | Safety Rules | 33 | How to Raise or Lower the Shoulder Straps |
| 8 | Your Car Seat | 36 | Using the Car Seat Outside the Vehicle |
| 9 | Your Car Seat Base | 39 | How to Use the Car Seat on Aircraft without the Base |
| 10 | Travel System | 40 | How to Use the Car Seat on Aircraft with the Base |
| 11 | Serial Numbers | 41 | Cleaning and Maintenance |
| 12 | Installation Instructions | 42 | How to Wash the Chair Padding-Cover removal |
| 13 | Installing the Base | 44 | How to Wash the Chair Padding-Retrofitting |
| 14 | How to Install the Base Using the LATCH SYSTEM | 45 | Replacement Parts |
| 17 | How to install the Base Using your VEHICLE SEAT BELT | | |
| 19 | Installing the Base with Different Types of Seat Belts | | |
| 21 | How to Install the Locking Clip | | |
| 22 | Different Types of Vehicle Seat Belts | | |





Before You Start

- 1** Please read this manual carefully. Keep this manual in the plastic pocket on the base of the infant car seat.
- 2** Review car seat parts and read through instructions. Also read the labels. Read and understand all instructions before using this car seat.
- 3** Fill in and return the registration form (see page 4).
- 4** All assembly must be performed by an adult.
- 5** Do not use the car seat if damaged or parts are missing.
- 6** Use only the parts or accessories that come with the unit. Do not modify or repair any part.
- 7** Remember: this car seat is to be installed rear facing only.
- 8** Peg Perego has the right to make changes to the product at any time without notice.





Customer Service

Call Peg Perego USA customer service at 1-800-671-1701 (toll free) for information about repairs or spare parts. If any part is missing or damaged, replace with Peg Perego parts only. See page 46 for a list of replacement parts.

If you want more than one base, you can purchase it from your local dealer, or you can call 1-800-671-1701 (toll free), or you can go to www.pegperego.com.

Registration Form

Important! Child restraints could be recalled for safety reasons. You must register this restraint to be reached in a recall. Send your name, address and the restraint's model number and manufacturing date to:

Peg Perego U.S.A., Inc.
3625 Independence Drive
Fort Wayne, IN 46808

Or call 1-800-671-1701 (toll free)

For recall information, call the U.S. Government's Vehicle Safety Hotline at 1-888-327-4236 (TTY: 1-800-424-9153).
Or go to <http://www.NHTSA.gov>





Safety

Warning

- This car seat meets or exceeds all applicable Federal Motor Vehicle Safety Standard 213 requirements for use in motor vehicles and aircraft.
- Your child could be seriously injured if you do not follow instructions and warning labels correctly.
- Use this car seat rear facing only. This seat is not designed to face forward. Serious injury or death can occur in an accident if you install the seat facing forward.
- Never use in a vehicle seat with an active air bag. Read your vehicle manual for instructions on how to turn off the air bag.
- If your vehicle has air bags, do not install this car seat on a seat with an active air bags. Death or serious injuries can occur if an air bag hits the unit (read your vehicle owner's

manual for instructions on where to install an infant car seat in your vehicle).



- This car seat is certified for use with or without base. Use of the base is highly recommended for ease of proper installation. Install this car seat without the base only if needed.
- Never install the car seat in the front vehicle seat unless instructed by your





vehicle manual. According to accident statistics, children are safer when properly restrained in the rear seating positions than in the front seating positions.

- Install this car seat on front facing seats only. Do not use on rear facing or side facing seats or in cars with door-mounted or motorized shoulder belts.
- If you use a lap belt or lap/shoulder belt to install the base, you must use a seat belt that locks in place. If it does not lock in place, use the locking clip. The seat belt must lock into place for the car seat to be properly secured.
- Be sure the car seat or car seat base are properly secured using a vehicle seat belt or LATCH as shown in this manual.
- Always buckle your baby into the car seat with the harness. Be sure to latch buckles correctly.
- When lifting the seat out of the base, be sure you first secure the handle

into the carrying position.

- Keep fingers away from moving parts.
- Use only approved parts. Use of unapproved parts can affect the safety of the car seat and cause serious injury or death in an accident.
- Complete and send in the registration form right away.
- Always store the manual with car seat. Keep it in the pocket on front of base.
- In case of accident: if this car seat is involved in a car accident, it may be no longer safe to use. You may need to get a new unit. Call customer service at 1-800-671-1701 (toll free) for more information.
- Do not use Primo Viaggio Sip ES 30•30 with bases manufactured before July 2006.





Safety Rules

- Use only with children who weigh between 5 and 30 pounds (2.3 and 13,5 kg) and whose height is 30 inches (76 cm) or less. If your baby was born with low birth weight, ask your doctor for special instructions on using an infant car seat.
- Use this car seat in vehicles with standard lap or lap/shoulder belts or universal lower anchors. If your vehicle has lower anchors, use those to secure the car seat instead of the standard seat belt. Read your vehicle manual to locate the lower anchors.
- Be sure the car seat is properly leveled. If the seat reclines too much, your baby can be injured or ejected from the seat. If the seat is too upright, it can cause your baby to have breathing problems, which could lead to injury or death.
- Do not place car seat on countertop, table, or soft surfaces.
- Never leave your baby alone in the car seat. He/she could get tangled in the straps and be seriously injured or could move or tip the seat.
- Do not leave the car seat or base unsecured in the vehicle, even if not occupied. A loose car seat can injure other passengers in a crash.
- Do not use this unit after five (5) years from the date of production labeled on the seat.
- Do not hang toys on handle of seat.





Your Car Seat

HOOD

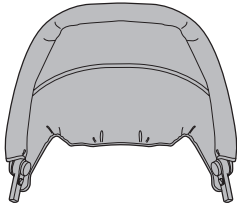

FRONT

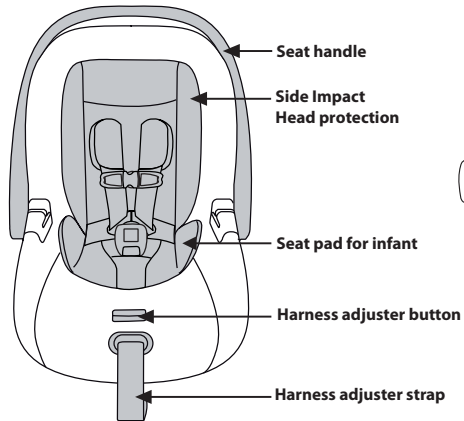

**5-POINT
HARNES SYSTEM**

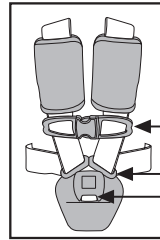

- Chest harness clip
- Harness latch plate
- Harness buckle

BACK

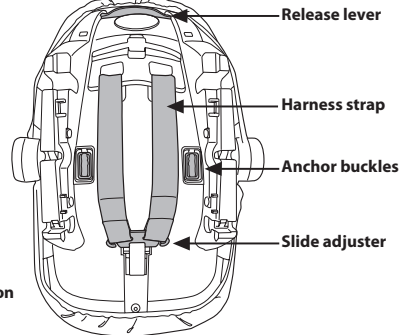

Energy absorbing Expanded Polystyrene (EPS) foam lined shell for added impact protection.





Your Car Seat Base

SIDE

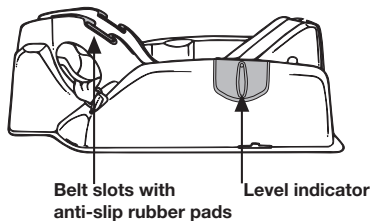

LOCKING CLIP STORAGE

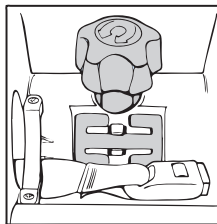

FRONT

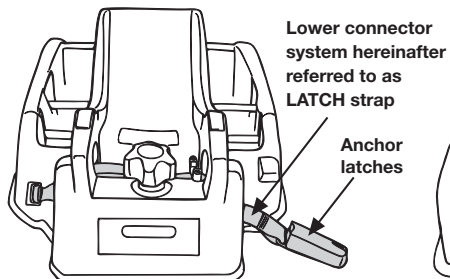

BACK

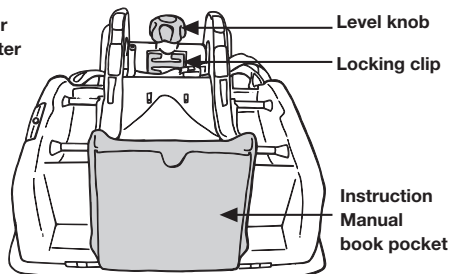



Travel System

Seat

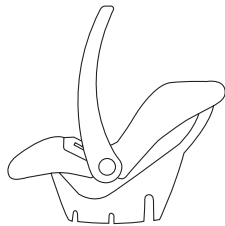

Base

Si

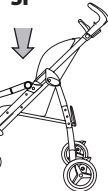

Duette SW

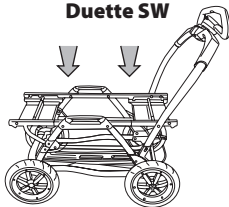

Triplette SW

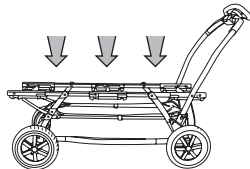

Aria Twin 6040



Pliko P3

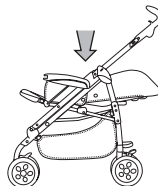

Pliko Switch

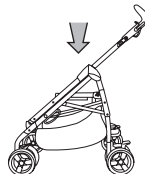

Uno

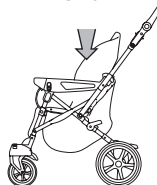

GT3/GT3 ForTwo

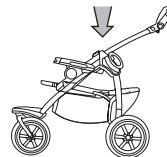

Aria



Skate

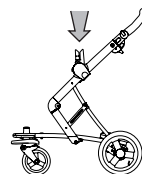



Serial Numbers

The following information can be found under the front of the seat of the Primo Viaggio Sip ES 30•30 : product name, production date and serial number.

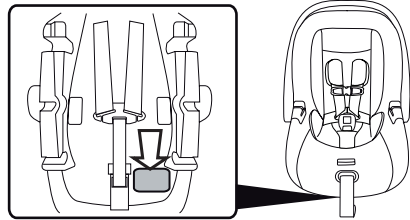

Buckle production date.

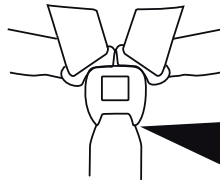

Harness production date.
In the event of problems with the product, these details will be of use to customers.

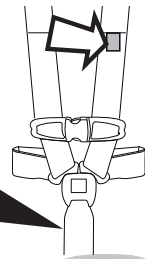
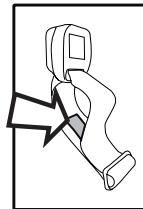
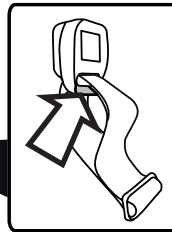

11





Installation Instructions

Peg Perego Primo Viaggio Sip ES 30•30 is certified for use with or without the base. Use of the base is highly recommended because it makes installation easier and therefore safer.

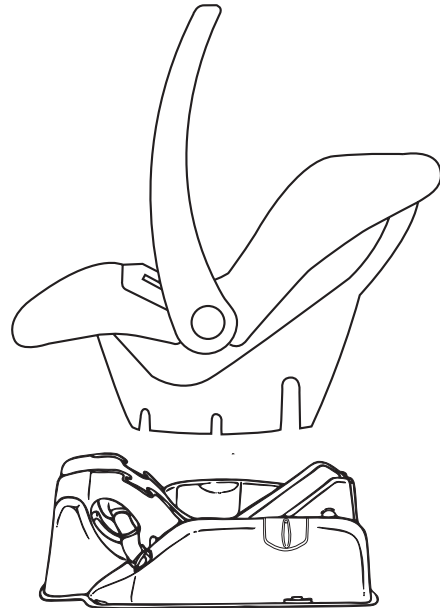



Installing the Base

When using Primo Viaggio Sip ES 30-30 with its base, first you install the base, and then you install the car seat on the base.

Important! Read your vehicle manual for instructions on where to best install an infant car seat in your vehicle.

There are two ways to install the base:

I USING THE LATCH

SYSTEM. If your car has “universal lower anchors”, you can install the infant car seat using the LATCH system instructions on page 14. The anchor is a bar located where the seat back meets the seat bottom (slide your hand down between the seat back and seat bottom to locate this bar).



Important! Also read your vehicle manual for locating lower anchors and instructions on using the LATCH system.

II USING THE STANDARD LAP BELT/ SHOULDER STRAP.

If your car does not have universal lower anchors, install the infant car seat using the instructions for lap belt/shoulder straps on page 17.



I - How to Install the Base Using the LATCH SYSTEM

Install the base with your vehicle parked on level ground.

- 1• Take the car seat off the base by moving the handle to the upright position. Place your hand on the top of the seat back and pull up on the handle with your fingers.

Note: Pulling near the center of the handle provides the easiest release.

- 2• Position the base rear facing in the back seat of your vehicle. Check the level indicator on the side of the base to make sure that the pointer is in the green area. If it is not, turn the knob left or right until it is in the correct position.

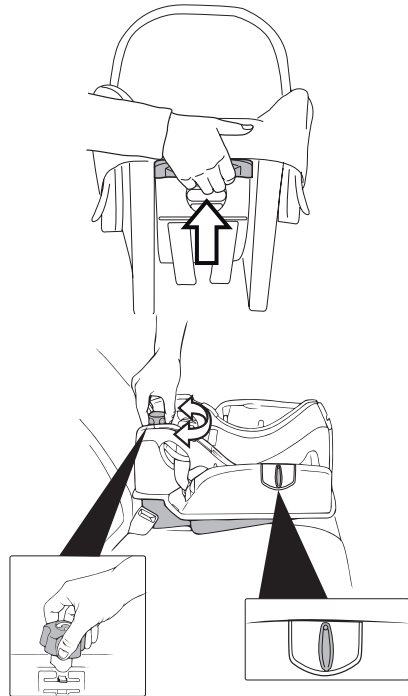



3. Remove the two anchor latches from their housings. The latches are on the sides of the base. First loosen the latch strap by pressing on the gray button and pulling the strap as shown. Then press the red button on top of the latch and pull the latch out of its housing. Repeat on other side.

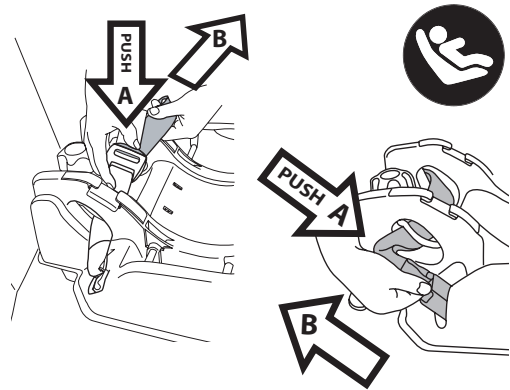

4. Push each latch onto the anchor bar located between your vehicle seat back and seat bottom. Press until you hear the click.

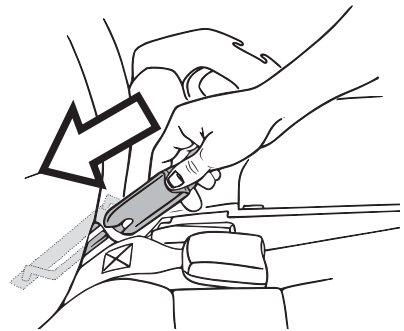
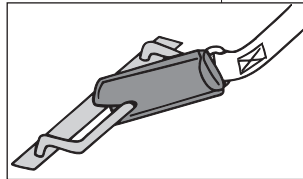



5. Make sure that the latch strap is threaded flat against the base.

6. Tighten the base against the seat by pulling the free end of the latch strap. Press down on the base with your body weight and tighten further. Check the level indicator. If the pointer has moved outside of the green area, turn the knob until the pointer is back within the green area. You may need to loosen the strap slightly to do this. Push and pull on the base. If you can move it more than 2,5 cm (1 inch), tighten the belt further.

- Now that you have installed the base, go to page 23.

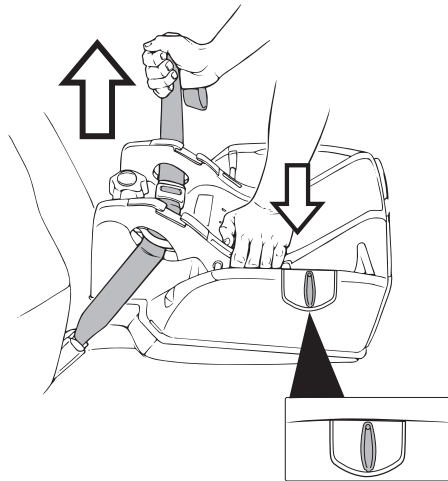
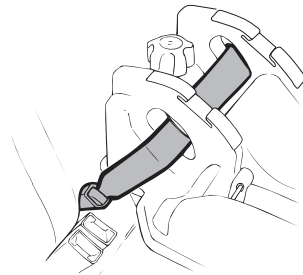



II - How to Install the Base Using Your VEHICLE SEAT BELT

Important! Not all seat belts work the same way. To make sure that the infant car seat is properly installed using your seat belts, read your vehicle owner's manual. It will suggest proper placement of an infant car seat in your particular vehicle.

Park your vehicle on level ground.

- 1• Take the car seat off the base by moving the handle to the upright position. Place your hand on the top of the seat back and pull up on the handle with your fingers.

Note: Pulling near the center of the handle provides the easiest release.

- 2• Position the base rear facing in the back seat of your vehicle. Check the level indicator on the side of the base to make sure that the pointer is in the green area. If it is not, turn the knob left or right until it is in the correct position.

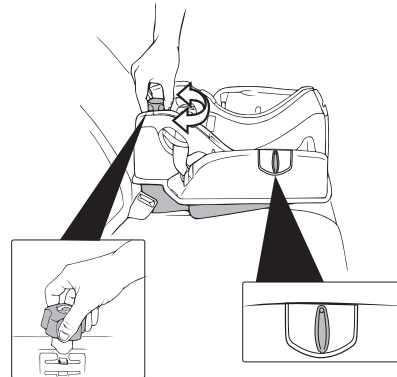
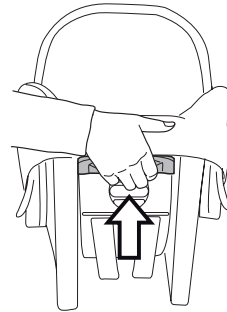



3. Thread the lap belt through the slots on the base and lock the latch plate into the buckle as shown.
4. Pull the strap to tighten the seat belt. Press down on the base with your body weight and pull the strap tighter. Then push and pull on the base. If you can move the base more than 2,5 cm (1 inch), tighten the belt further. Once the base is tight, check the level indicator. If the pointer has moved outside of the green area, turn the knob until the pointer is back within the green area. You may need to loosen the strap slightly to do this.

Warning! If you cannot get the belt tight enough, refer to your vehicle manual for instructions on how to secure the base using the type of seat belt in your vehicle. Your baby is not safe riding in a loose car seat.

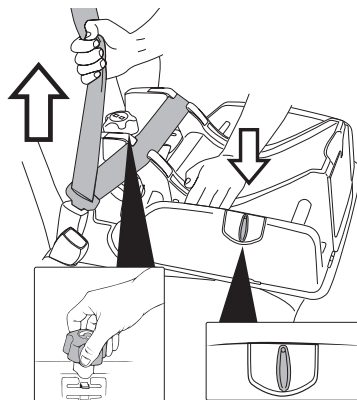
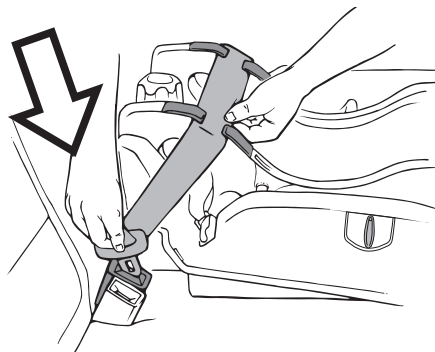



Installing the Base with Different Types of Seat Belts

Primo Viaggio Sip ES 30•30 is designed for use with lap or lap/shoulder seat belts. Four of the most common types are listed below. Please read your vehicle manual for instructions on installing an infant car seat using your vehicle seat belts.

I Lap/Shoulder belt with Switchable Locking Retractor

If your vehicle has Switchable Locking Retractor lap/shoulder belts, pull the shoulder strap all the way out, let it retract several inches, then pull it out again. It should lock in place to properly secure the base.

II Lap/Shoulder belt with Emergency Locking Retractor (ELR) and free sliding latch plate

This type of seat belt will only lock in an emergency, so you must use the locking clip (stored on infant seat base) to properly secure this type of seat belt (see page 21).

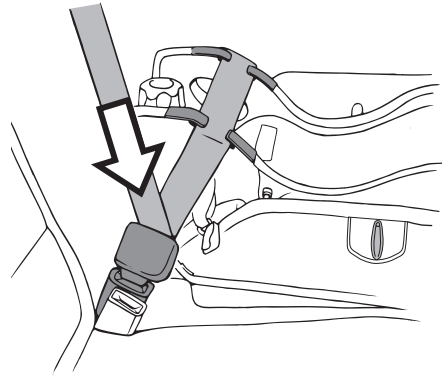



III Lap/shoulder belt with a locking latch plate

If you have a lap/shoulder belt with a locking latch plate and the belt comes loose after buckling, unbuckle it, flip it over, and re-buckle. This will usually keep the seat belt locked in place. If not, read your vehicle manual for specific instructions.

IV Different Types of Lap Belts

Lap belts with Emergency Locking Retractors (ELR), Automatic Locking Retractors (ALR), and Switching Locking Retractors (SLR) look as shown. Consult your vehicle owner's manual to determine which style you have. Lap belts with locking latch plates look as shown.

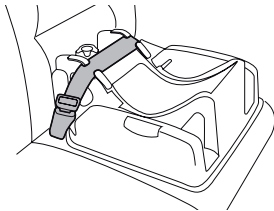

V Lap belt only with an Emergency Locking Retractor

If you have a lap belt (without shoulder strap) that locks only in an emergency (ELR), do not use it to secure the Primo Viaggio Sip 30-30 car seat. Please consult a certified Child Passenger Safety Technician for other installation options.



To find a technician in your area, go to: <http://www.nhtsa.dot.gov/people/injury/childps/contacts/index.cfm>, or call 1-888-327-4236.





How to Install the Locking Clip

To install the locking clip, hold the shoulder strap and lap belt together just above the buckle. Unbuckle the belt while holding the straps. Hook the locking clip around both straps as shown.

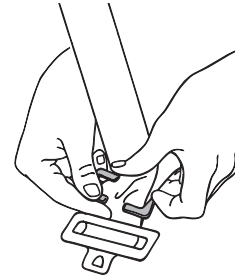
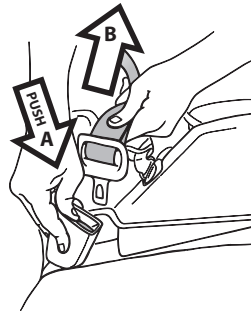

Leave 1/2 inch space between the clip and latch. Re-buckle the belt.

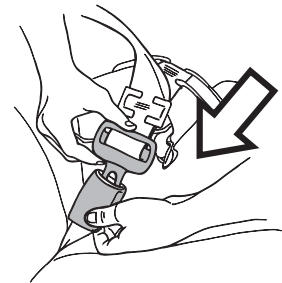
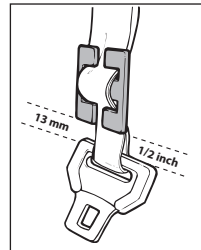



Different Types of Vehicle Seat Belts

Important! Do not install this car seat on seats with:

- A** Lap/motorized shoulder belts.
- B** Belts mounted on the door.
- C** Side-facing seats.
- D** Rear-facing seats or seats that rotate.

For your child's safety, always read your vehicle manual for instructions on installing child car seats.



A

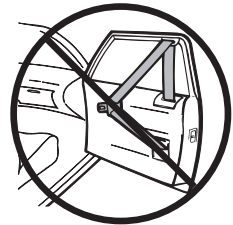

B

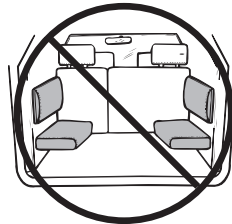

C



D





Installing the Car Seat on the Base

Now that you have installed the base in your vehicle, you are ready to install the car seat on the base.

- 1• Holding the car seat by the handle, press it rear facing on the base until you hear the click. You will not be able to move the car seat if it is properly locked in place. Check to make sure the base is still level. If not, remove the car seat and properly adjust the base.

Important! Newborn infants should be properly reclined. If the seat reclines too much, your baby can be ejected from the seat in an accident. If too upright, it can cause breathing problems.

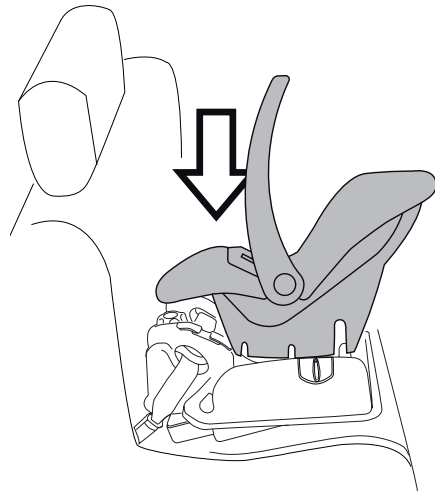



2. Adjust the handle so it rests at the top edge of the car seat as shown. Any other position may injure your baby in an accident. To rotate the handlebar, press each of the round buttons (located on each side of the handle where it attaches to the seat) and rotate it to the position required.

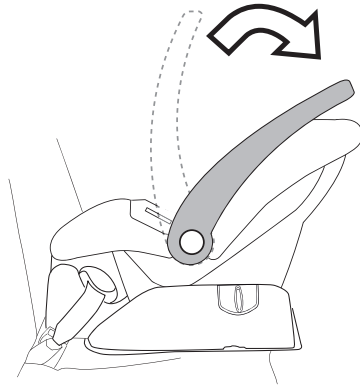

3. To remove the car seat, move the handle to the upright position. Place your hand on the top of the seat back and pull up on the handle with your fingers.
Note: Pulling near the center of the handle provides the easiest release.

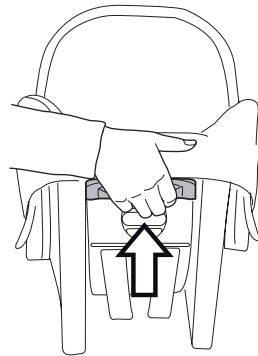



Installing the Car Seat without the Base

Important! The base is designed to avoid consumer misuse by reducing the number of times the seat must be anchored to your vehicle. Please, use and install Primo Viaggio Sip ES 30•30 without the base only if needed. Park the vehicle on level ground.

- 1• Position the restraint on the seat, so your baby is facing the rear of the vehicle. Adjust the handle so it rests at the top edge of the car seat as shown. Any other position may injure your baby in an accident. To move the handle, press the gray buttons on the sides of the handle at the same time and push the handle.

Important! The seat must be parallel to the ground. If necessary, use rolled towels or pool noodles under the seat at vehicle seat crease, so the red line on the side of the seat is parallel with the ground.

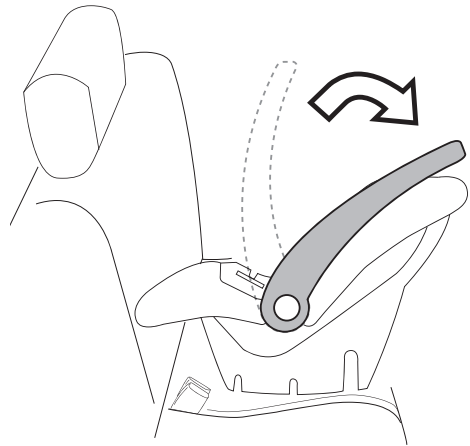



2. Adjust the restraint on the seat. Check the red line to see that the base is level with the ground. Thread the lap belt through the slots on the seat and lock the latch plate into the buckle as shown.
3. Pull the strap to tighten the seat belt. Press down on the seat with your body weight and pull the strap tighter. Once the seat is tight, check that the red line on the side of the car seat is level with the ground.

Warning! If you cannot get the belt tight enough, refer to your vehicle manual for instructions on how to secure the seat using the type of seat belt in your vehicle. Your baby is not safe riding in a loose car seat.

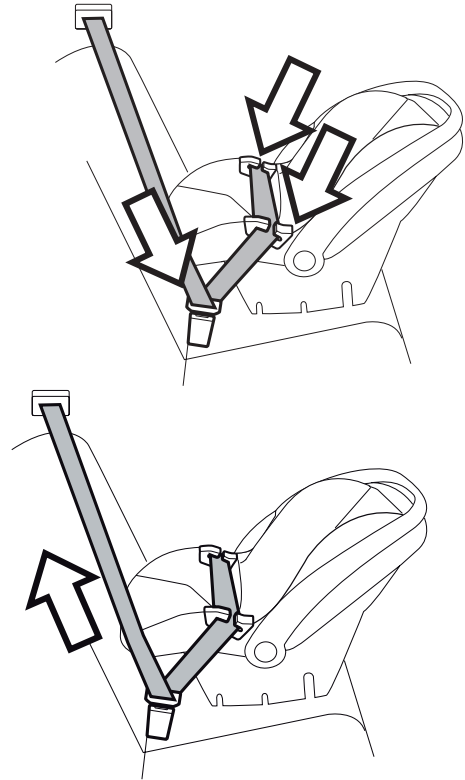



Installing the Seat with Different Types of Seat Belts

Installation of Primo Viaggio Sip ES 30•30 without base follows the same rules as with base regarding the availability of different types of vehicle seat belts.

Important! For different types of seat belts, please refer to page 19 and 20.

Should your vehicle belt need a locking clip, please refer to page 21 for installation details. Illustration in this page shows the completed installation.

Primo Viaggio Sip ES 30•30 should not be installed on seat types shown on page 22.

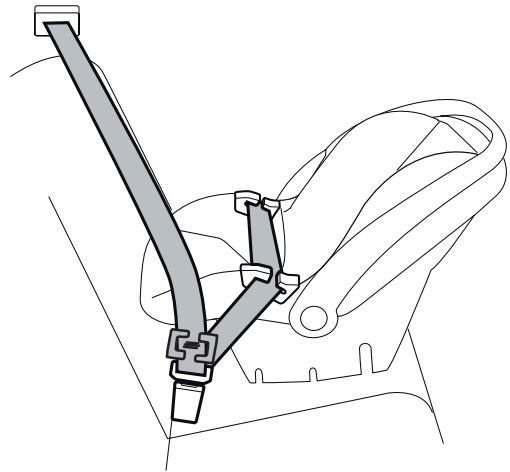



How to Buckle Your Baby into the Car Seat

This restraint uses a 5-point harness system to secure your baby into the car seat. See illustration on page 8.

- 1• Push the red buckle button to release the harness. Press and hold the harness adjuster button while pulling the shoulder straps out. Lay the shoulder straps to the side to make room for your baby.
- 2• Put your baby in the car seat with their bottom and back flat against the child restraint. Bring the two shoulder straps over your baby's shoulders. Make sure the straps are not twisted behind the backrest or over your baby's chest.

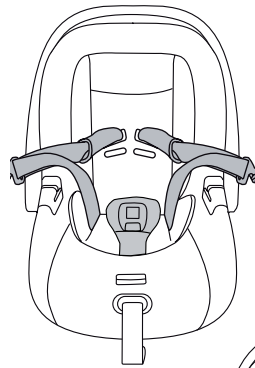



- 3• Insert both latch plates into the buckle until you hear them click. Pull on straps to make sure that both plates are latched securely. (Note: You may need to adjust the shoulder height. See How to Raise or Lower the Shoulder Straps on page 33).

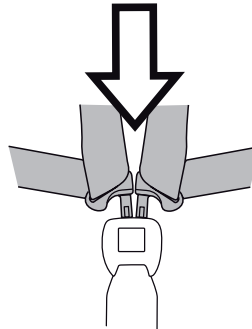

- 4• Latch the two chest clips together.

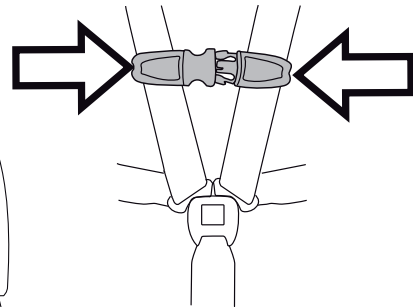



- 5•** To undo the chest clip, press the buttons on the side of the clip and pull apart as shown.

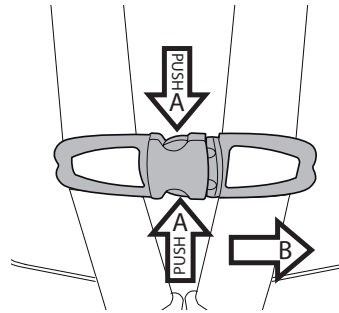

- 6•** To undo the latch plates, press the red button and pull the latches up.

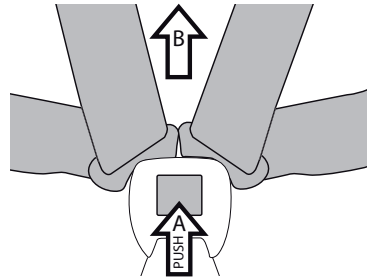



7• Adjust the chest clip to the arm pit level. To tighten the harness, pull the adjuster strap at the bottom of seat until strap is snug. Make sure you leave one finger width between the harness and your baby's collar bone. Tuck the loose end of the adjuster strap under the seat padding.

8• To loosen the harness, press and hold the harness adjuster button inside the slot located at your baby's feet, and pull the top harness as shown.

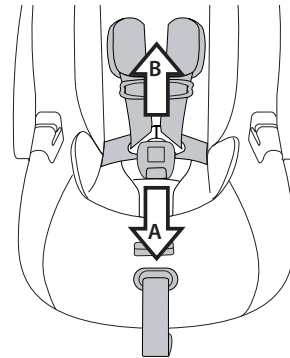
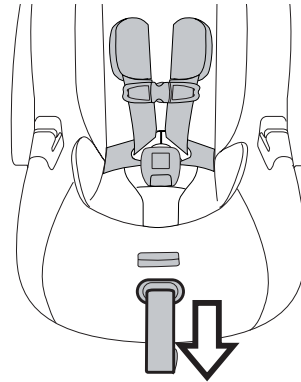



- 9• As your baby grows, you may need to lengthen the shoulder straps. This is done by moving the harness straps to the second position on the slide adjuster as shown.

Important! A snug strap should not allow any slack. It lies in a relatively straight line without sagging. It does not press on the child's flesh or push the child's body into an unnatural position.

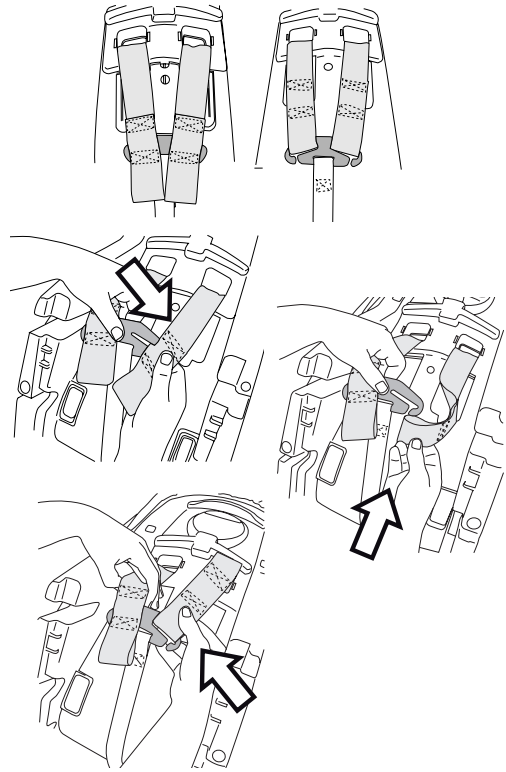



How to Raise or Lower the Shoulder Straps

- 1• In order to raise or lower the shoulder straps : detach the belt from the plate at the back (fig. a) and unthread the shoulder straps from the holes.

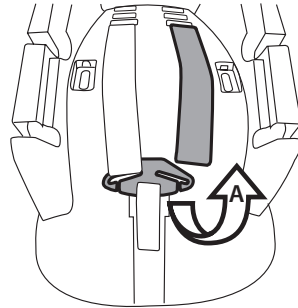

- 2• Reposition them from the front toward the back in the most appropriate hole for the height of the child (fig. b). Reattach the strap terminals to the metal plate.

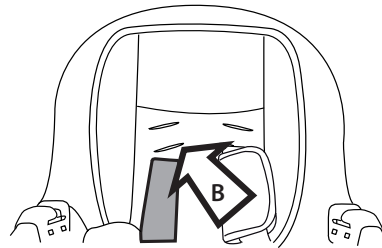



- 3• The correct position is when the shoulder strap slot is located just below shoulder level, as shown.

Important! This restraint is designed for infants up to 76 cm (30 inches) in length. The top of the infant head should not exceed the top of the seat back.

Important! Make sure that the chest harness and all straps are flat and not twisted on the back or the front of the car seat.

- 4• To fit the protective cushion, it is necessary to release the crotch strap first from under the seat.

- 5• Once this is done, slip the padding onto the the crotch strap.

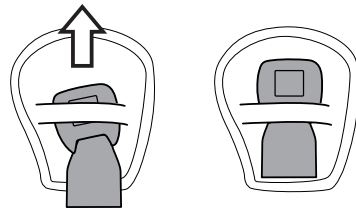
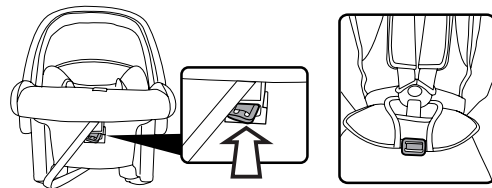
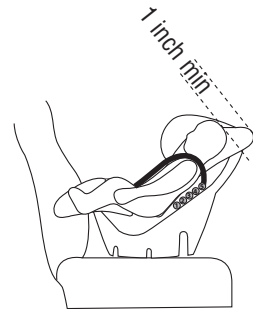



- 6• To fit the two shoulder protectors, open the Velcro as shown in the figure.

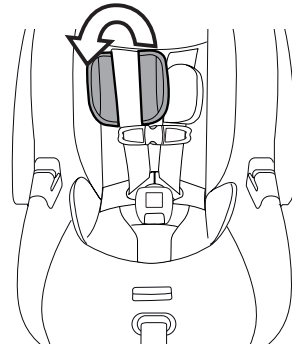

- 7• To fit the booster cushion, thread the safety harness (1) and the leg divider strap (2) through the slots in the cushion. Figure B shows the correct fitting of the booster cushion.

Important! The seat is supplied with a filler cushion for new-born babies. This can be removed when the child grows. Even when using the cushion make sure the shoulder straps are positioned correctly. See figure.

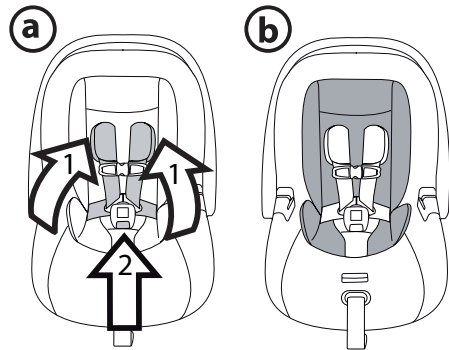



Using the Car Seat Outside the Vehicle

This unit can be used as an infant seat. The special shell shape is designed for rocking your baby.

The hood provides shade for your baby.

- 1• To rock your baby, move the handle into the up position as shown. To prevent rocking, lock the handle behind the backrest.

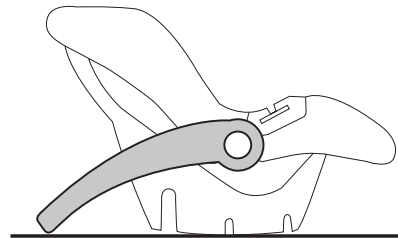
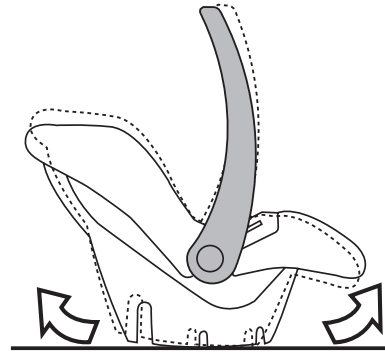



2• To attach the hood, push the hood latch into the slot on the seat shell as shown. To open the hood, pull the frame until it clicks open.

3• To adjust the hood position, simply push into the desired position.

4• To remove the hood, push the buttons and remove the latches from the seat shell.

Warning! The hood must not be used to lift the safety seat because it might detach.

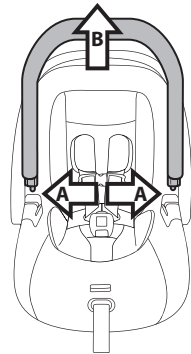
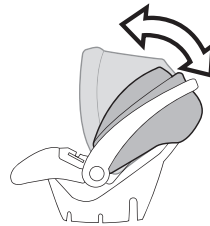
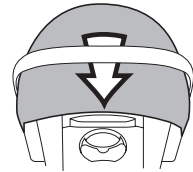
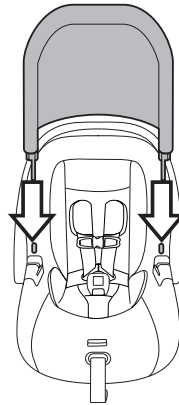



5• Carrying handle for Base.

Warning! Do not use with the seat attached to the base.

Warning! Do not use as a means of transporting child.

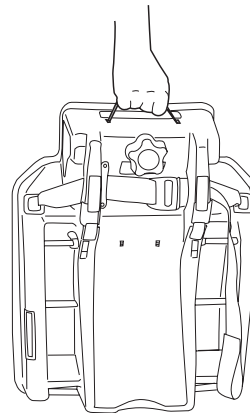



How to Use the Car Seat on Aircraft without Base

This unit is certified for aircraft use.

- 1• Position the restraint on the seat, adjust the handle so it rests at the top edge of the car seat as shown. Any other position may injure your baby in an accident. To move the handle, press the gray buttons on the sides of the handle at the same time and push the handle.
- 2• Adjust the restraint on the seat. Check the red line to see that the base is level with the ground. Thread the lap belt through the slots on the seat and lock the latch plate into the buckle as shown.
- 3• Pull the strap to tighten the seat belt. Press down on the seat with your body weight and pull the strap tighter. Once the seat is tight, check that the red line on the side of the car seat is level with the ground.

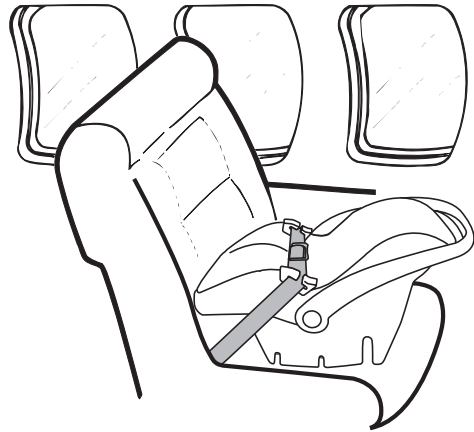

Important! Follow the harness instructions beginning with “How to Buckle Your Baby into the Car Seat” (on page 28) to safely secure your baby.





How to Use the Car Seat on Aircraft with Base

This unit is certified for aircraft use.

- 1• Buckle the base to the aircraft seat using the lap belt as shown. A secondary belt path can also be used as shown in Fig. B.
- 2• Position the base rear facing in the aircraft seat. Check the level indicator on the side of the base to make sure that the ball is in the green area. If it is not, turn the knob left or right until it is in the correct position.
- 3• Thread the lap belt through the slots on the base and lock the latch plate into the buckle.
- 4• Pull the seat belt strap to tighten the base down. Press your body weight down on the seat to tighten the belt further. Check the level and adjust if needed. Push and pull on the base. If you can move it more than one inch, tighten the belt further. Position the car seat rear facing over the base. Press the seat into the base until you hear the click. Make sure the seat is correctly locked in place.

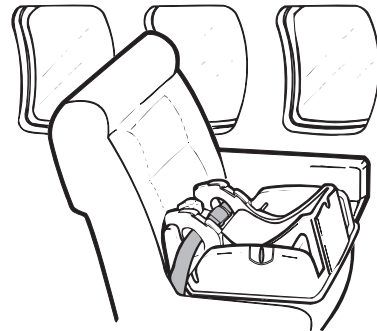
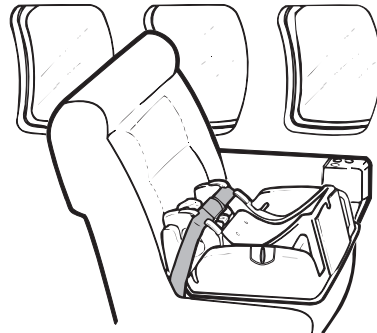



Cleaning and Maintenance

This unit needs minimal maintenance.

- Keep all moving parts clean. Lubricate with light oil, if necessary on moving parts.
- Clean the plastic parts often with a damp cloth. Do not use solvents or harsh products.
- Brush the fabric parts to remove dust.
- Protect the product against snow, water, and rain. Constant exposure to sunlight can change the colors in the material. Sun can also make the seat very hot. Be sure it is cool before putting your baby in the seat.
- Excessive exposure to the sun for long periods of time can make the plastic brittle.
- Store product in a dry area.

Warning! Do not use or purchase the car seat 5 (five) years after the production date labelled on the seat or shell.





How to Wash the Chair Padding - Cover removal

1• To remove the safety seat harness:

- Press the harness adjuster button in the centre of the seat to extend the safety harness straps;
- Press the red button on the crotch strap buckle to release the harness;
- Release the harness straps from the slide adjuster on the back of the safety seat and unthread them from the headrest and shoulder covers;
- Remove the two plastic covers on the back of the safety seat by levering with a standard tip screwdriver, and unthread the two side buckles and the central crotch strap buckle.

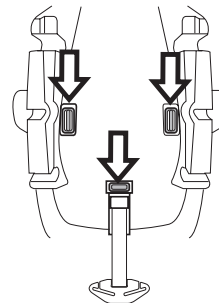
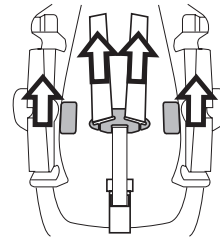





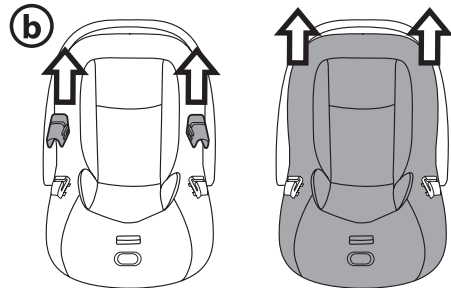
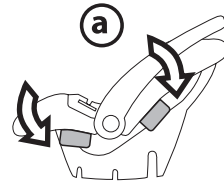

2• To remove the padding:

- Unthread the four cover fixing tabs from the edge of the car seat (fig. a).
- Use a flat screwdriver to lever and release the two plastic protectors on the side guides of the car seat belt (fig. b).
- Remove the padding.



Padding cleaning instructions

-  • hand wash at max 86° F (30° C), do not wring;
-  • do not iron;
-  • do not bleach with chlorine;
-  • do not dry clean, do not use solvent based stain removers;
-  • do not tumble dry.





How to Wash the Chair Padding - Refitting

1• To refit the padding:

- Position on the seat.
- Insert the four fixing tabs along the edge of the car seat.
- Position the two car seat belt side guide protectors with the openings facing towards the car seat and check that they are correctly engaged.

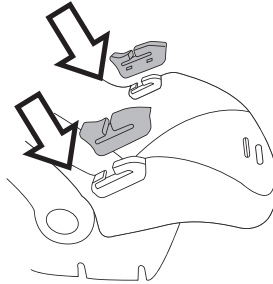

2• To refit the safety harness:

Important! when fitted (as described in section 3), it must not be twisted.

- From the front of the car seat insert the safety harness shoulder straps into the shoulder slots and then attach them to the metal buckle at the rear of the car seat.
- Insert the two safety harness side buckles and the central buckle of the leg divider strap into their slots and replace the two plastic covers.

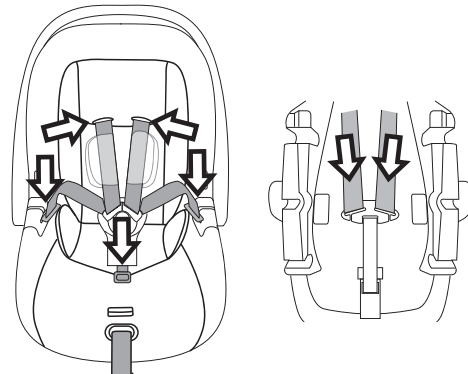



Replacement Parts

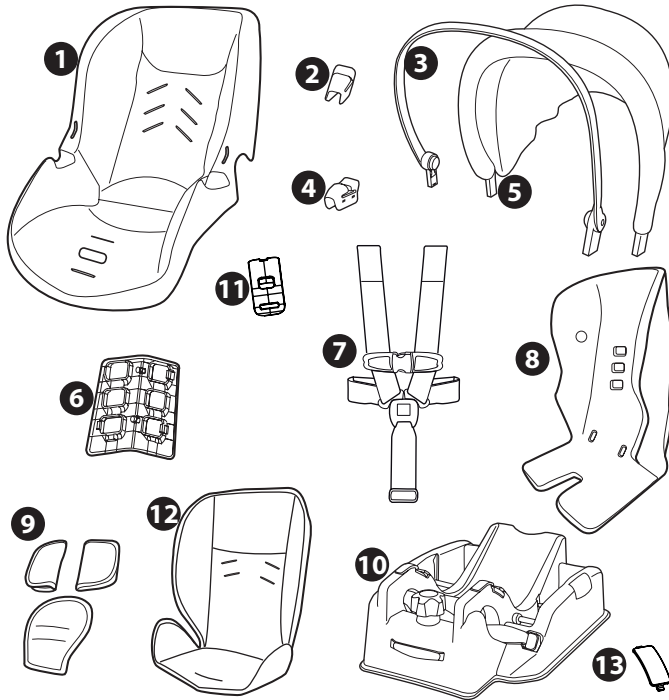

- 1) BSATES•
- 2) SPST6341DGR
- 3) SAPI5714GR
- 4) SPST6341SGR
- 5) BCATES•
- 6) SPST6553KNF
- 7) MUCI0055GR
- 8) MMSP0040
- 9) BAKTES•
- 10) IAKADJUSNF
- 11) SPST6850GL
- 12) BRITES•
- 13) SPST5712•

NOTE: Spare parts available in different colors* to be specified when ordering.

NOTE: A Tether is not a component of a rear facing only car seat.







Piezas de repuesto

- 1) BSATES.
- 2) SPST6341DGR
- 3) SAP15714GR
- 4) SPST63415GR
- 5) BCATES.
- 6) SPST6553KNF
- 7) MUCIO055GR
- 8) MMSFP0040
- 9) BAKTES.
- 10) IAKADJUSNF
- 11) SPST6850GL
- 12) BRITES.
- 13) SPST5712.

NOTA: Cuando haga su pedido especifique los colores* de las piezas de repuesto.

NOTA: Un Tether no es un componente de silla de auto orientada hacia atrás.

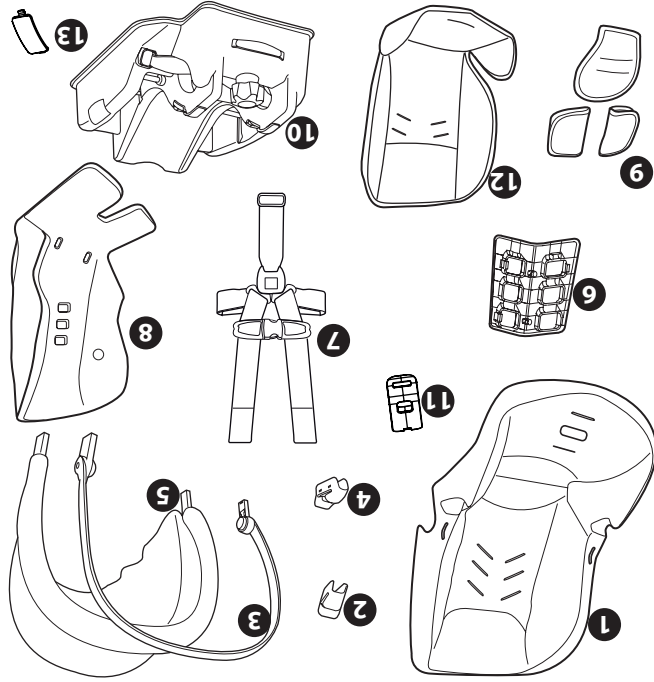

Cómo lavar el acolchado de la silla - Enfundar

1. Para volver a colocar el forro:

- colocar el forro;

- introducir las 4 aletas de fijación del forro en el borde de la silla de auto;

- colocar las dos tapas de las guías laterales por el cinturón del coche con las hendiduras orientadas hacia el interior de la silla de auto y asegurarse del correcto enganche.

- **Para volver a montar el cinturón de seguridad: IMPORANTE:** colocar el cinturón tal y como se describe en el apartado 3. No debe estar arrugado.

- introducir por la parte delantera de la silla las correas del cinturón de seguridad en los cubrehombros y,

después, engancharlas a la hebilla de hierro por la parte trasera de la silla;

- introducir las dos hebillas laterales del cinturón de seguridad y la central de la entrepierna en los respectivos



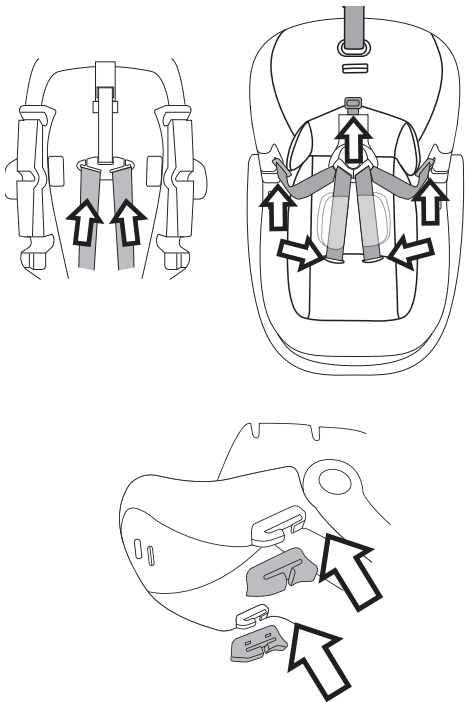

alojamientos y volver a colocar las dos tapas de plástico.



2. Quitar el forro:

- quitar las 4 aletas de fijación del forro del borde de la silla de auto (fig. a);
- quitar las dos tapas de plástico de las guías laterales, haciendo palanca con un destornillador llano, por el cinturón del automóvil (fig. b);
- quitar el forro.

Mantenimiento del acolchado

-  Laver à la main uniquement,
- température maximale 30°C,
-  No planchar;
-  No poner en lejía;
-  No limpiar en seco;
-  No centrifugar

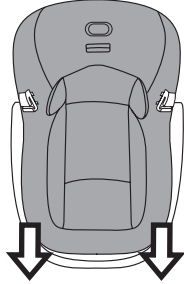
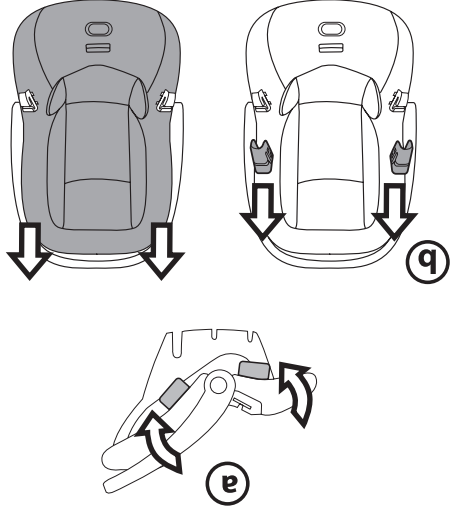

Cómo lavar el acolchado de la silla - Desenfundable

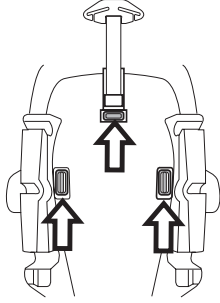
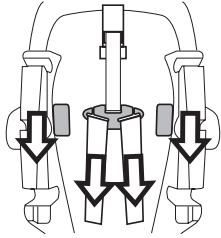

1. Para desmontar el cinturón de seguridad de la silla de auto:

- Presionar el botón metálico que se halla en el centro de la silla para alargar las correas de hombros del cinturón de seguridad;
- Pulsar el botón rojo de la hebilla entrepieñas para desabrochar el cinturón de seguridad;
- Desenganchar las correas de hombros del cinturón de seguridad en la hebilla de hierro situada en el respaldo de la silla y sacarlas del reposacabezas y del cubre-hombros;
- Quitar, haciendo palanca con un destornillador plano, las dos cubiertas de plástico colocadas en el respaldo de la silla y sacar las dos hebillas laterales del cinturón y la central de la tira entrepieñas.

Limpeza y mantenimiento

Esta unidad requiere un mantenimiento mínimo.

- Mantenga limpias todas las partes móviles. Lubrique las partes móviles con un aceite liviano si es necesario.
- Limpie las partes plásticas con frecuencia utilizando un paño húmedo. No utilice solventes ni productos fuertes.
- Cepille las partes de tela para eliminar el polvo.

- Proteja el producto de la nieve, el agua y la lluvia. La exposición constante a la luz solar puede cambiar los colores del material. El sol puede recalentar la silla. Antes de colocar a su bebé en la silla, asegúrese de que la silla no esté caliente.
- La exposición al sol durante periodos prolongados puede resquebrajar el plástico.
- Guarde el producto en un lugar seco.

Advertencia! No utilice ni compre una silla de auto si han pasado 5 (cinco) años o más desde la fecha de producción etiquetada en la silla o en el armazón.

Uso de la silla de auto en el avión con la base

Esta unidad está certificada para el uso en aviones.

- 1 • Abroche la base al asiento del avión utilizando el cinturón de cadera como muestra la figura. Puede utilizarse un paso secundario para el cinturón como indica la figura B.

- 2 • Coloque la base orientada hacia atrás en el asiento del avión. Controle el indicador de nivel al costado de la base para asegurarse de que la bola esté en el área verde. En caso contrario, gire el pomo hacia la izquierda o la derecha hasta que esté en la posición correcta.

- 3 • Haga pasar el cinturón de cadera por las ranuras de la base y bloquee la placa del seguro en la hebilla.

- 4 • Tire de la correa del cinturón para apretar la base hacia abajo. Haga presión con su cuerpo sobre el asiento para apretar el cinturón aún más. Controle el nivel y ajústelo si es necesario. Empuje y tire de la base. Si se desliza más de una pulgada, apriete el cinturón aún más. Coloque la silla de auto orientada hacia atrás sobre la base. Empuje la silla sobre la base hasta oír el clic del enganche. Asegúrese de que la silla esté correctamente bloqueada en su lugar.

40

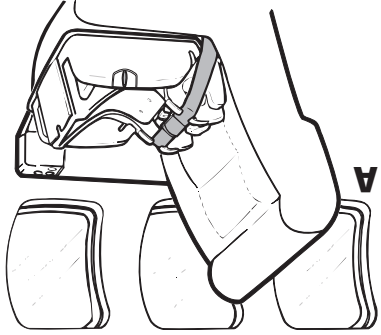

A

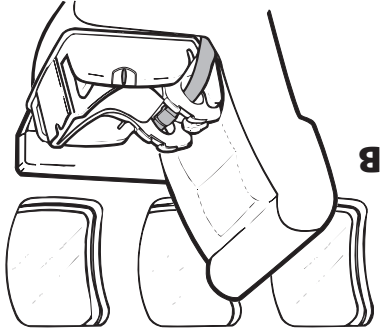

B

Esta unidad está certificada para el uso en aviones.

1. Coloque el dispositivo de retención sobre el asiento y ajuste el asa de modo que descansa sobre el borde superior de la silla de auto como indica la figura. Cualquiera otra posición puede provocar heridas al debe en un accidente. Para mover el asa, pulse simultáneamente los botones grises laterales y empujela.
2. Ajuste el dispositivo de retención en el asiento. Compruebe que la base esté paralela al suelo observando la línea roja. Haga pasar el cinturón de cadera por las ranuras de la silla y bloquee la placa del seguro en la hebilla como indica la figura.
3. Tire de la correa para apretar el cinturón de seguridad. Presione la silla con el peso de su cuerpo para apretar la correa aún más. Una vez

Uso de la silla de auto en el avión sin la base

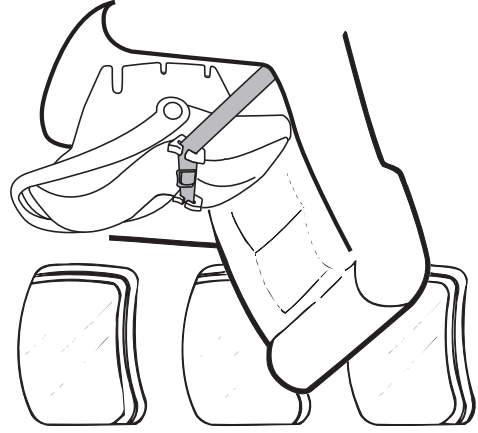

ajustada la silla, compruebe que la línea roja al costado de la silla quede paralela al suelo.

Importante! Siga las instrucciones del arnés sobre «Como sujetar a su bebé en la silla de auto» (página 28) para sujetar a su bebé correctamente.

5. Asa de transporte para la base.

Advertencia! No la utilice con la silla acoplada a la base.

Advertencia! No la utilice como medio para transportar al niño.

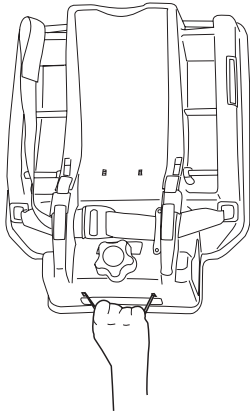



- 2. Para montar la capota, empuje el seguro de la capota en la ranura de la silla como indica la figura. Para abrir la capota, tire del armazón hasta que se abra con un clic.

- 3. Para ajustar la posición de la capota, simplemente empujela a la posición deseada.

- 4. Para quitar la capota, pulse los botones y quite los seguros de la silla.

Importante: la capota no tiene que usarse para levantar la silla ya que puede soltarse.

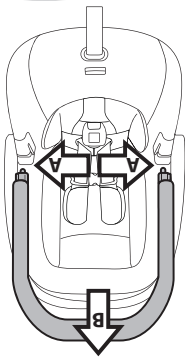
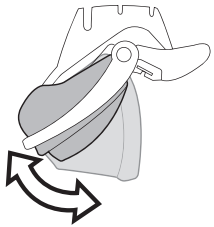
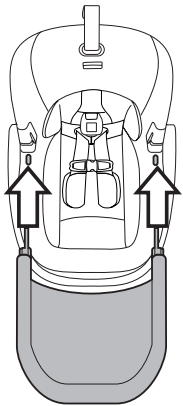

37

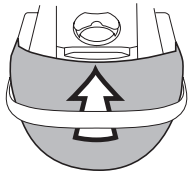

Uso de la silla de auto fuera del vehículo

Esta unidad puede utilizarse como silla para niños. Está diseñada con forma de caparazón para acunar al bebé. La capota hace sombra.

- 1 Para acunar a su bebé, levante el asa como indica la figura. Para impedir el balanceo, bloquee el asa detrás del respaldo.

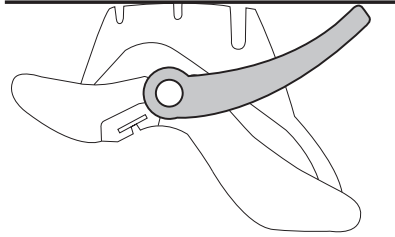
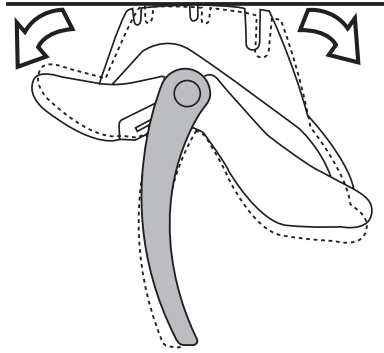

6 Para instalar las dos protecciones para los hombros, abrir el velcro tal y como muestra la figura.

7 Para instalar el cojín reductor, deben meterse los cinturones de seguridad (1) y la tira entrepiernas (2) en los orificios del cojín. La figura B indica la correcta instalación del cojín reductor.

Importante! La silla de auto se entrega con un cojín reductor para el recién nacido que puede quitarse al crecer el niño. Asegurarse de la correcta posición de las correas incluso cuando se use el reductor. Véase la imagen.

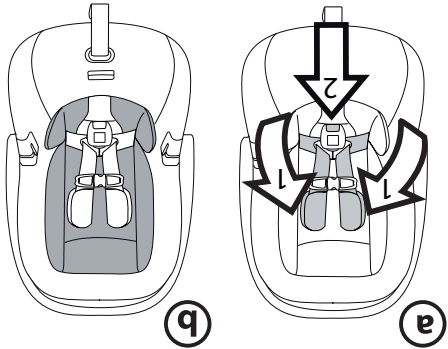
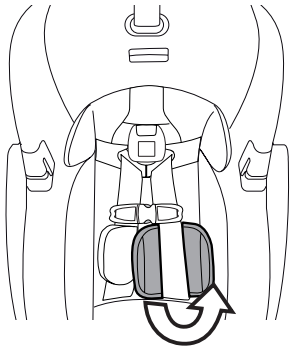

3. La posición correcta es aquella en la que la ranura de la correa de hombro queda precisamente debajo del nivel del hombro como indica la figura.

Importante! Este dispositivo de

retención está diseñado para niños de hasta 30 pulgadas de estatura. La cabeza del niño no debería sobrepasar el respaldo de la silla.

Importante! Asegúrese de que el arnés pectoral y todas las correas queden planos y no retorcidos detrás o delante de la silla de auto.

4. Para instalar el cojín de protección de las piernas, deberá primero desenganchar la tira entrepieñas por debajo del asiento,

5. y, después, introducir la tira entrepieñas en el acolchado.

34

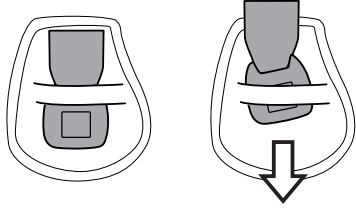
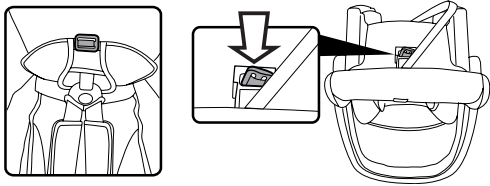
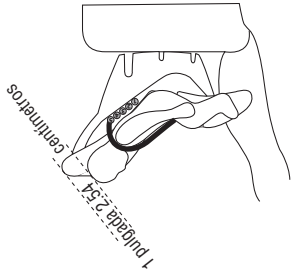

Cómo levantar o bajar las correas de hombro

1. Para subir o bajar las correas de los hombros: soltar el cinturón de la placa trasera (fig. a) y quitar las correas de los hombros de los agujeros.

2. Colocarías de nuevo desde la parte delantera hacia la espalda en el agujero más adecuado para la altura del bebé (fig. b). Sujetar de nuevo los extremos de las correas a la placa de metal.

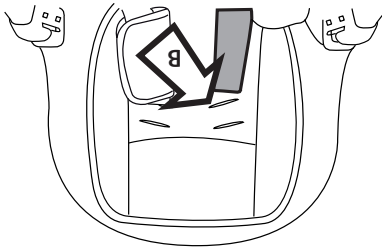
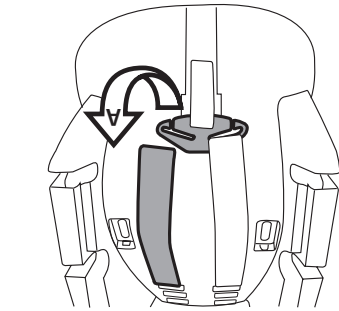

9. A medida que su bebé crezca, podría ser necesario alargar las correas de hombro. Esto se hace colocando las correas del arnés en la segunda posición del regulador deslizante como indica la figura.

Importante! Una correa cenida no debería permitir ningún aflojamiento sino mantener una línea relativamente recta sin ceder, pero sin tampoco hacer presión sobre el bebé ni empujar el cuerpo a una posición que no sea natural.

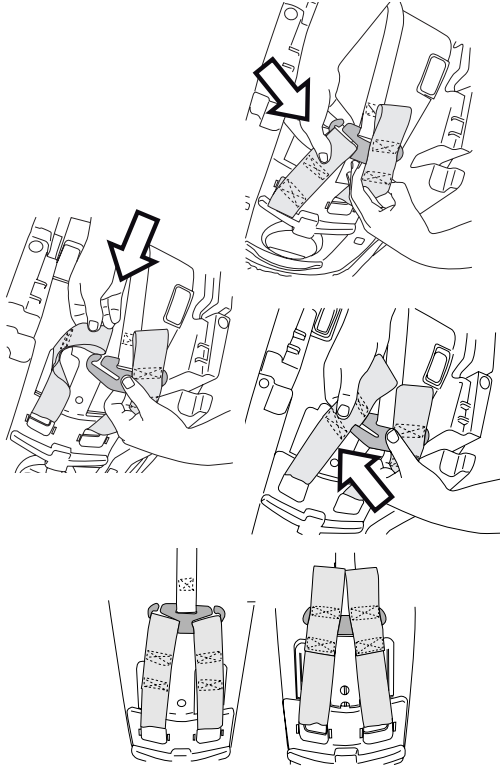

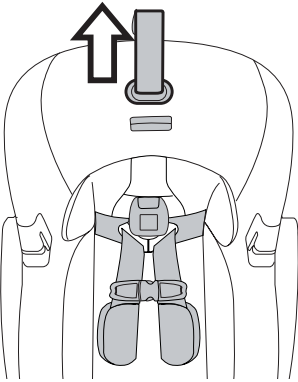

- 7 •** Ajuste el clip pectoral al nivel de la axila. Para apretar el arnés, tire de la correa de ajuste del fondo de la silla hasta que quede ceñida. Asegúrese de dejar un dedo de distancia entre el arnés y la clavícula del bebé. Meta el extremo suelto de la correa de ajuste debajo del acolchado de la silla.

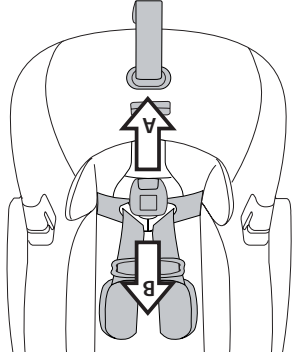

- 8 •** Para aflojar el arnés, pulse y mantenga pulsado el botón de ajuste del arnés dentro de la ranura ubicada a los pies de su bebé y tire del arnés como indica la figura.

- 5.** Para desabrochar los clips pectorales, pulse los botones laterales, tire y sepárelos como indica la figura.

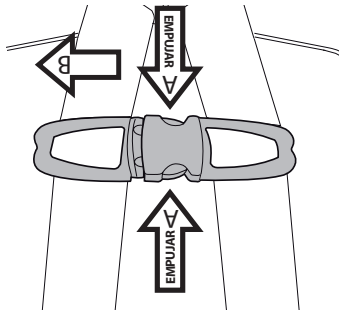

- 6.** Para desabrochar las placas del seguro, pulse el botón rojo y tire hacia arriba.

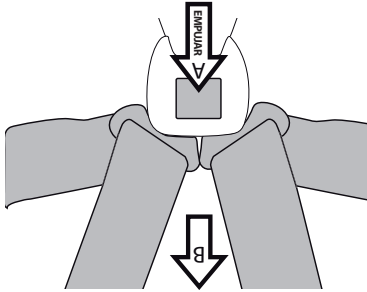



4. Abroche los dos clips pectorales.

3. Introducir ambas placas de cierre en la hebilla hasta oír el clic. Tirar de las correas para asegurarse de que ambas placas estén correctamente enganchadas. (Nota: Puede que deba ajustar la altura del hombro. Consultar Como Subir o Bajar los Tirantes en la página 33).

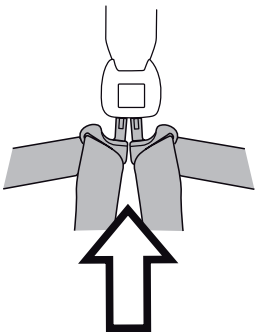
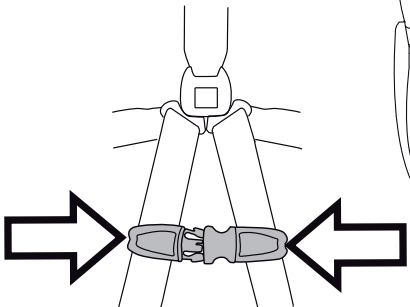
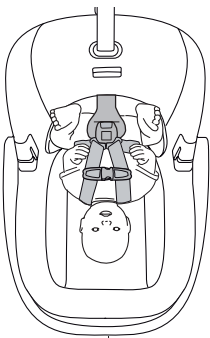

Cómo sujetar a su bebé en la silla de auto

Este dispositivo de retención aplica un sistema de arneses de 5 puntos para sujetar al bebé en la silla de auto. Vea la ilustración en la página 8.

1• Pulse el botón rojo de la hebilla para abrir el arnés. Mantenga pulsado el botón de ajuste del arnés mientras tira de las correas de hombro al Costado para dar lugar a su bebé.

2• Coloque a su bebé en la silla de auto con la cadera y la espalda pegadas al dispositivo de sujeción. Lleve las dos correas de hombro sobre los hombros del bebé. Asegúrese de que las correas no estén retorcidas detrás del respaldo o sobre el pecho del bebé.

28

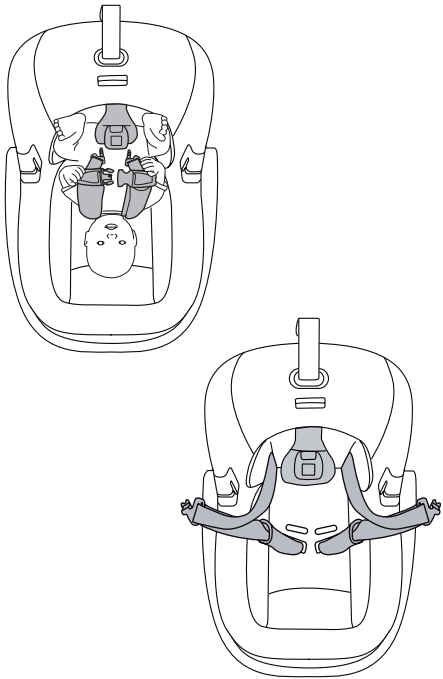

Primo Viaggio Sip ES 30•30 sin base se instala del mismo modo que con base en función de la disponibilidad de los diferentes cinturones de seguridad.

Importante! Para otros tipos de cinturón, consulte las páginas 19 y 20.

Si el cinturón necesita una presilla de bloqueo, ver página 21 para las instrucciones de instalación. El ejemplo que figura en esta página muestra una instalación completa.

Primo Viaggio Sip ES 30•30 no debería instalarse en los tipos de asiento de la página 22.

Instalación de la silla con diferentes tipos de cinturones de seguridad

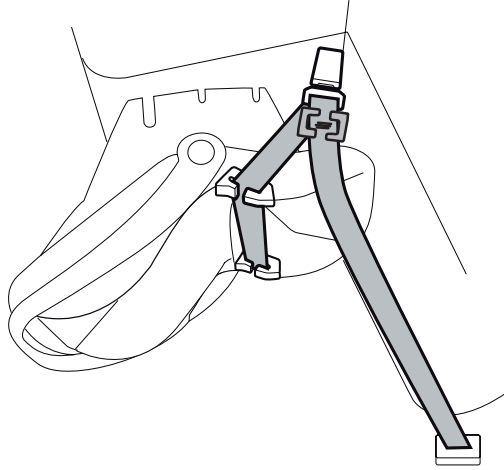

2. Ajuste el dispositivo de retención en el asiento. Compruebe que la base esté paralela al suelo observando la línea roja. Haga pasar el cinturón de cadera por las ranuras de la silla y bloquee la placa del seguro en la hebilla como indica la figura.

3. Tire de la correa para apretar el cinturón de seguridad. Presione la silla con el peso de su cuerpo para apretar la correa aún más. Una vez ajustada la silla, compruebe que la línea roja al costado de la silla quede paralela al suelo.

Advertencia! Si no puede apretar el cinturón lo suficiente, consulte el manual de instrucciones de su vehículo para saber cómo asegurar la silla utilizando el tipo de cinturón de seguridad de su vehículo. Su bebé no estará a salvo en una silla de auto floja.

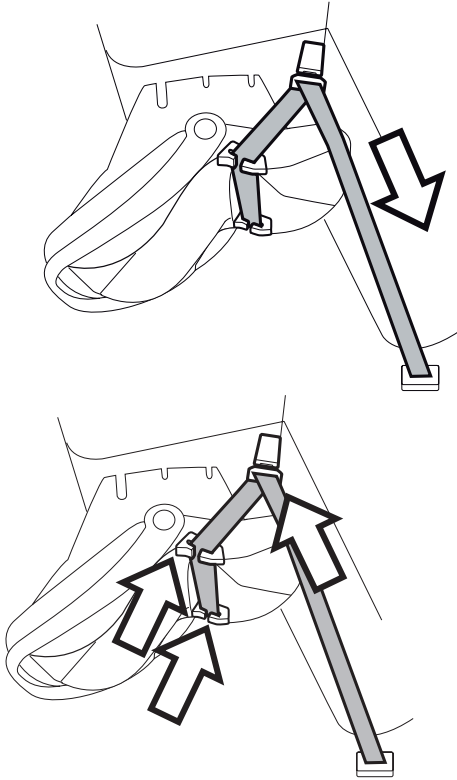

Instalación de la silla de auto sin la base

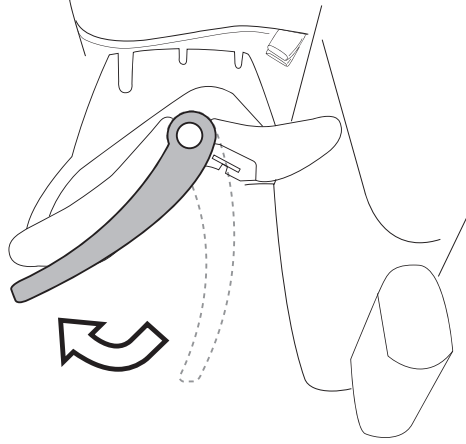

25

Importante! La base está diseñada para evitar el uso erróneo, ya que evita tener que fijar la silla en el vehículo cada vez que se utiliza. Utilice e instale Primo Viaggio Síp ES 30-30 sin la base sólo en caso de necesidad. Aparque el vehículo sobre un terreno llano.

1 • Coloque el dispositivo de retención

sobre el asiento de modo que quede orientado hacia atrás. El asa debe descansar sobre el borde superior de la silla de auto como indica la figura. Cualquiera otra posición puede provocar heridas al bebé en un accidente. Para mover el asa, pulse simultáneamente los botones grises laterales y empujela.

Importante! La silla debe estar paralela al suelo. Si es necesario, coloque una toalla enrollada o un tubo de goma debajo de la silla, donde está el pliegue del asiento del vehículo, de modo que la línea roja al costado de la silla quede paralela al suelo.

2. El asa debe descansar sobre el borde superior de la silla de auto como indica la figura. Cualquiera otra posición puede provocar heridas al bebé en un accidente. Para mover el asa presione los botones redondos del asa colocándolo simultáneamente en la posición deseada.
3. Para quitar la silla de coche, colocar la palanca en posición vertical. Situar la mano en la parte superior del respaldo y tirar de la palanca con los dedos. **Nota:** La silla se quitará con más facilidad si se tira cerca del centro de la palanca.

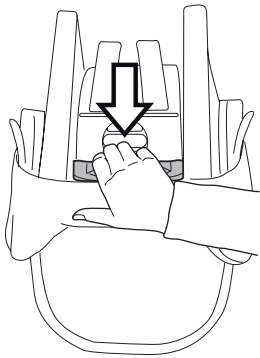
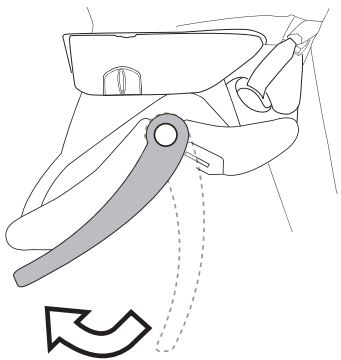

Instalación de la silla de auto sobre la base

Ahora que la base está instalada en su vehículo, puede instalar la silla de auto sobre la base.

- 1** • Sosteniendo la silla de auto por el asa, móntela orientada hacia atrás presionándola sobre la base hasta oír el clic. Si la silla de auto está bien bloqueada, no debería ser posible moverla. Compruebe que la base esté todavía nivelada correctamente. De lo contrario, quite la silla de auto y ajuste la base adecuadamente.

Importante! Los recién nacidos deberían estar reclinados correctamente. Si la silla está demasiado reclinada, su bebé podría lastimarse o ser expulsado de la silla en un accidente. Si la silla está demasiado erguida, su bebé podría tener dificultades para respirar.

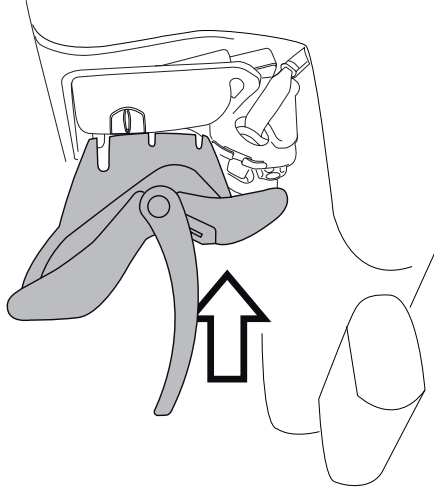

Diferentes tipos de cinturones de seguridad

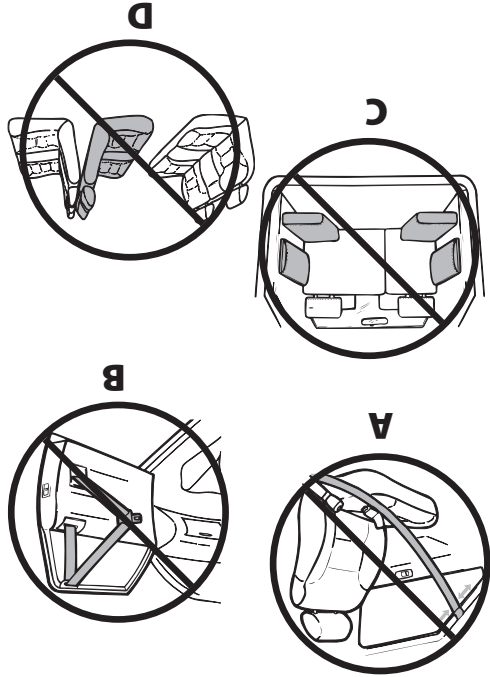

Importante! No instale esta silla de auto en asientos con:

A Cinturones de cadera/hombro motorizados.

B Cinturones montados en la puerta.

C Asientos orientados hacia los costados.

D Asientos orientados hacia atrás o giratorios.

Para la seguridad de su niño, siempre lea en el manual de su vehículo las instrucciones de instalación de sillas de auto para niños.



21

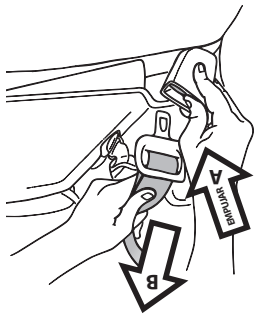
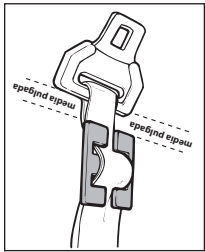
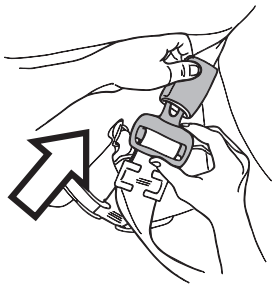

Deje media pulgada entre el clip y el seguro. Abroche de nuevo el cinturón.

Para instalar el clip de bloqueo, sostenga la correa de hombro y el cinturón de cadera juntos, sobre la hebilla. Desabroche el cinturón sosteniendo las correas. Enganche el clip de bloqueo en torno a ambas correas como indica la figura.

Cómo instalar el clip de bloqueo



clip de bloqueo (guardado en la base de la silla) para poder asegurarlo adecuadamente (página 21).

III Cinturón de cadera/hombro con placa de seguro con bloqueo

Si tiene un cinturón de cadera/hombro con placa de seguro con bloqueo y el cinturón queda suelto después de abrocharlo, desabróchelo, invértalo y vuelva a abrocharlo. De este modo el cinturón debería quedar bloqueado. Si no, lea instrucciones más específicas en el manual de su vehículo.

IV Tipos Diferentes de Cinturones Abdominales

Cinturones abdominales dotados de Retractores de Bloqueo de Emergencia, Retractores de Bloqueo Automático y Retractores de Bloqueo de Posición tal y como se muestra en la figura. Consultar el manual de su vehículo para saber el tipo de cinturón del que dispone. Cinturones abdominales con placas de cierre con agarre tal y como se muestra en la figura.

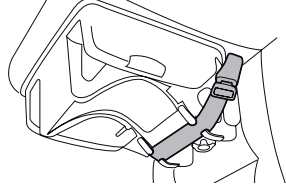

V Cinturón de cadera sólo con

retractor de bloqueo de emergencia Si tiene un cinturón de cadera (sin correa de hombro) que se bloquea sólo en caso de emergencia, no lo utilice para asegurar la silla de auto Primo Viaggio Sip 30-30. Consulte con un técnico de seguridad de pasajeros infantiles certificado para que le indique las opciones de instalación.

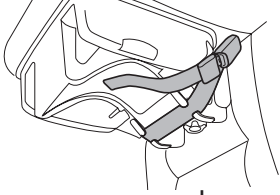

Para conseguir un técnico en su zona visite <http://www.nhtsa.dot.gov/people/injury/childps/contact/index.cfm> o llame al 1-888-327-4236.

Instalación de la base con diferentes tipos de cinturones de seguridad

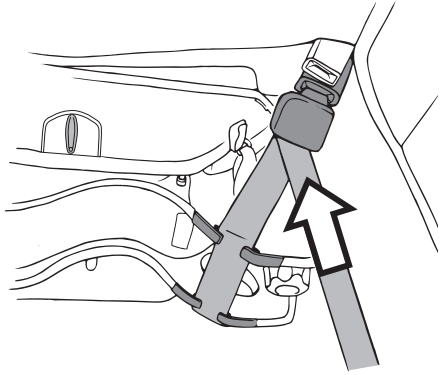

Primo Viaggio Sip ES 30-30 está diseñada para utilizarse con cinturones de seguridad de cadera o de hombro. A continuación se listan cuatro de los tipos más comunes. Lea el manual de instrucciones de su vehículo para saber cómo instalar una silla de auto para niños utilizando los cinturones de seguridad del vehículo.

I Cinturón de cadera/hombro con retractor de bloqueo conmutable

cadera/hombro con retractor de bloqueo hasta el tope, deje que se retraiga varias pulgadas y luego vuelva a tirar. Debería quedar bloqueada para asegurar la base adecuadamente.

II Cinturón de cadera/hombro con retractor de bloqueo de emergencia y placa de seguro libre

Este tipo de cinturón de seguridad se bloquea sólo en una emergencia, por lo que será necesario utilizar el

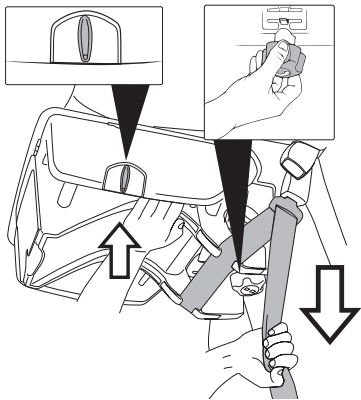
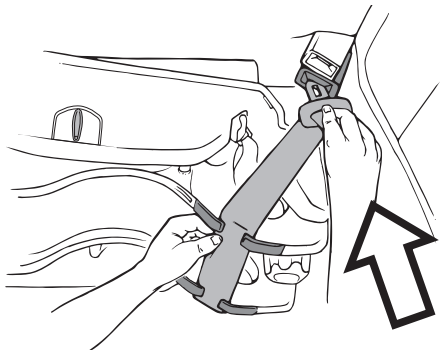

pomo hacia la izquierda o la derecha hasta que esté en la posición correcta.

3. Haga pasar el cinturón de cadera por las ranuras de la base y bloquee la placa del seguro en la hebilla como indica la figura.

4. Tire de la correa para apretar el

cinturón de seguridad. Presione la base con el peso de su cuerpo para apretar la correa aún más. Empuje y tire de la base. Si la base se desliza más de una pulgada, apríete el cinturón aún más. Con la base bien apretada, controle el indicador de nivel. Si se hubiese salido del área verde, gire el pomo hasta que el indicador vuelva a estar dentro del área. Para ello puede ser necesario aflojar la correa ligeramente.

Advertencia! Si no puede apretar el cinturón lo suficiente, consulte el manual de instrucciones de su vehículo para saber cómo asegurar la base utilizando el cinturón de seguridad de su vehículo. Su bebé no estará a salvo en una silla de auto floja.

II - Cómo instalar la base utilizando los CINTURONES DE SEGURIDAD DEL VEHÍCULO

Importante! No todos los cinturones de seguridad funcionan de la misma manera. Para asegurarse de que la silla de auto para niños esté bien instalada de auto para niños de seguridad, lea el manual de su vehículo. El manual le indicará cómo montar la silla de auto correctamente en su vehículo.

Aparque el vehículo sobre un terreno llano.

1. Quitar la silla de coche de la base colocando la palanca en posición vertical. Situar la mano en la parte superior del respaldo y tirar de la palanca con los dedos.
Nota: La silla se quitará con más facilidad si se tira cerca del centro de la palanca.
2. Coloque la base orientada hacia atrás sobre el asiento trasero del vehículo.

Controlé que el indicador de nivel, situado en el lateral de la base, se encuentra en el área verde. En caso contrario, gire el

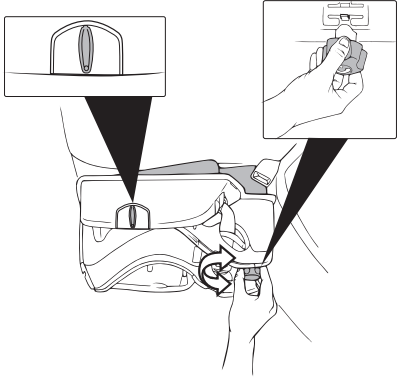
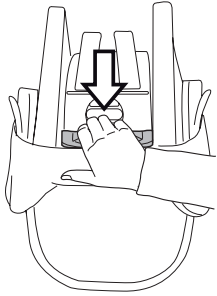

- **5.** Asegúrese de que la correa del seguro esté colocada planamente contra la base.

- **6.** Apriete la base contra el asiento tirando del extremo libre de la correa de seguridad. Empuje la base con el peso de su cuerpo para apretarla más. Controle el indicador de nivel. Si se hubiese salido del área verde, vuelva a estar dentro del área. Para ello puede ser necesario aflojar la correa ligeramente. Empuje y tire de la base. Si se desplaza más de una pulgada, apriete el cinturón aun más.
- Una vez instalada la base, vaya a la página 23.

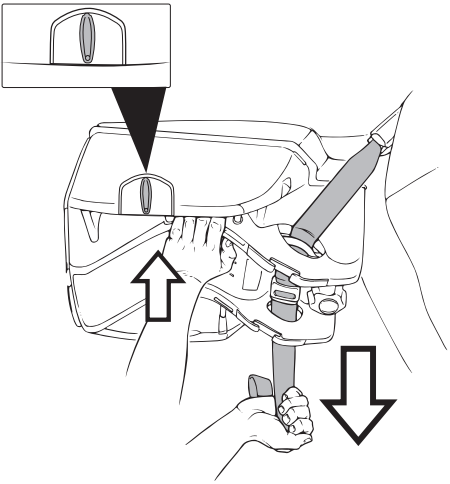
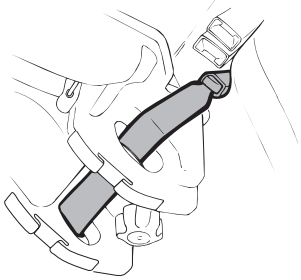

- 3.** Quite los dos seguros de anclaje de sus alojamientos. Los seguros están a los costados de la base. Primero afloje la correa del seguro pulsando el botón gris y tirando de la correa como indica la figura. Pulse el botón rojo sobre el seguro y quite el seguro de su alojamiento. Repita la operación del otro lado.

- 4.** Empuje cada seguro en la barra de anclaje ubicada entre el respaldo y el fondo del asiento de su vehículo. Presione hasta oír el clic.

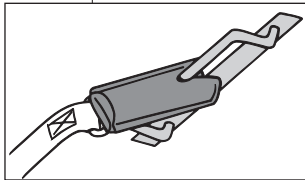
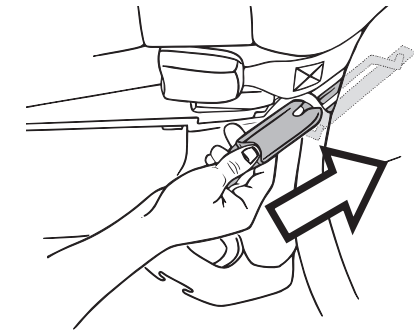
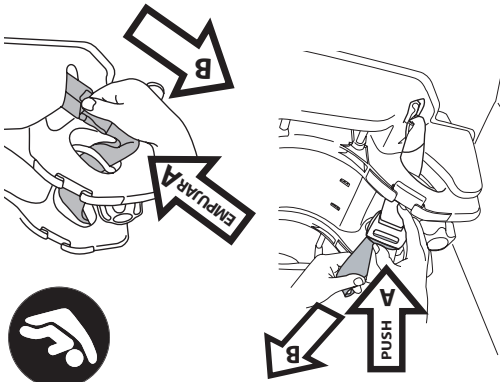

I - Cómo instalar la base utilizando el sistema de seguro LATCH SYSTEM

Instale la base con el vehículo aparcado sobre un terreno llano.

1. Quitar la silla de coche de la base colocando la palanca en posición vertical. Situar la mano en la parte superior del respaldo y tirar de la palanca con los dedos.
Nota: La silla se quitará con más facilidad si se tira cerca del centro de la palanca.

2. Coloque la base orientada hacia atrás sobre el asiento trasero del vehículo. Controle que el indicador de nivel, situado en el lateral de la base, se encuentra en el área verde. En caso contrario, gire el pomo hacia la izquierda o la derecha hasta que esté en la posición correcta.

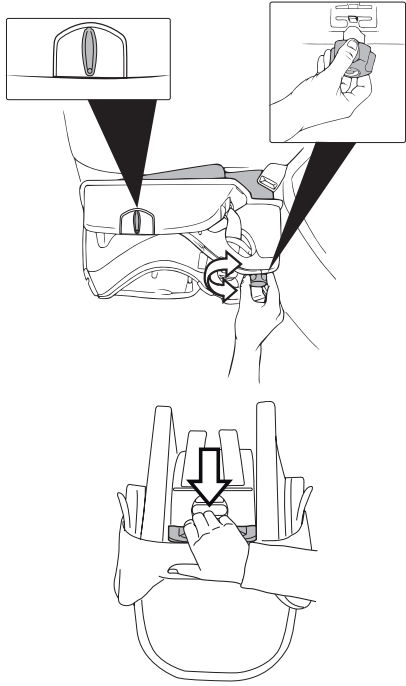

Instalación de la base

Para utilizar Primo Viaggio Sip ES 30-30 con la base, primero hay que instalar la base y luego la silla de auto sobre la base.

Importante! Lea el manual de instrucciones de su vehículo para saber en qué parte del vehículo se puede instalar mejor una silla de auto para niños.

Hay dos maneras de instalar la base:

I CON EL SISTEMA DE

seguro LATCH SYSTEM.



Si su vehículo tiene «anclajes inferiores universales», puede

instalar la silla de auto para niños utilizando el sistema de

seguro: vea las instrucciones en la página 14. El anclaje es una barra

ubicada en la línea de intersección entre el respaldo y el fondo del

asiento (deslice la mano entre el respaldo y el fondo del asiento para

localizar esta barra).

Importante! Lea el manual de su vehículo para localizar los anclajes

inferiores y lea las instrucciones de uso del sistema de seguro LATCH SYSTEM.

II CON EL CINTURÓN

DE CADERA O LA CORREA

DE HOMBRO ESTÁNDAR. Si su

vehículo no tiene anclajes inferiores universales, instale la silla de

auto para niños siguiendo las

instrucciones de uso del cinturón de cadera o la correa de hombro en la

página 17.

Instrucciones de instalación

Peg Perego Primo Viaggio Sip ES 30•30
está certificada para utilizarse con o
sin base. Se recomienda utilizar la base
para que la instalación resulte más
fácil y, por lo tanto, segura.

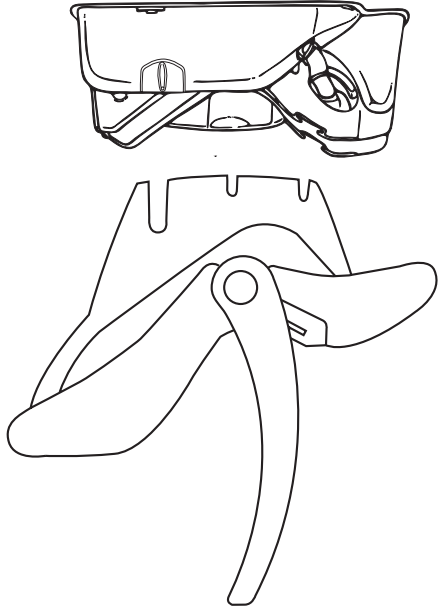

Números de Serie

Primo Viaggio Sip ES 30•30 contiene
debajo de la parte delantera de su
asiento las siguientes informaciones:
Nombre del producto, fecha de
fabricación y número de serie.

Fecha de fabricación
de la hebilla.

Fecha de fabricación del arnés.
Estos elementos son de utilidad para el
consumidor en caso de que el producto
presente anomalías.

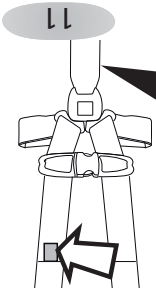
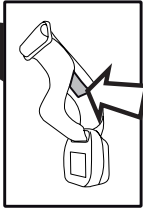
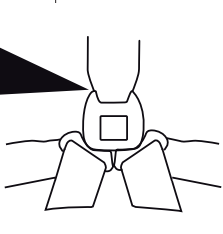
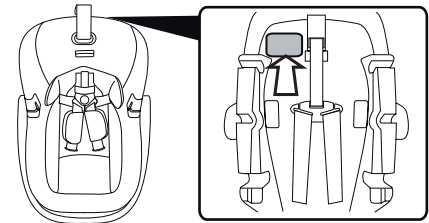



Sistema de Viaje

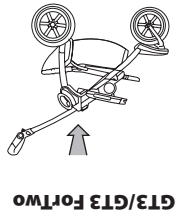

GT3/GT3 ForTwo

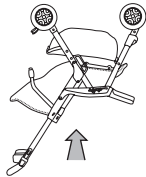

Aria

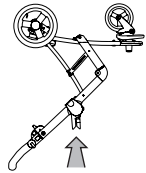

Skate

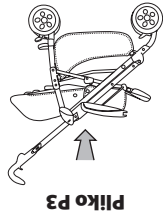

Pliko P3

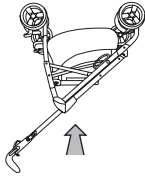

Pliko Switch

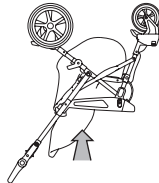

Uno

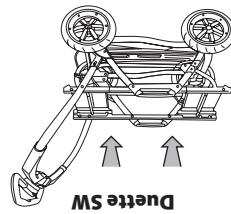

Duette SW

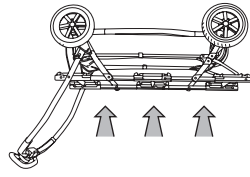

Triplette SW

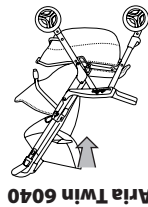

Aria Twin 6040

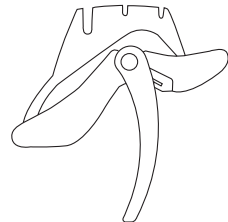

Silla



Base

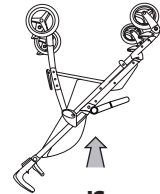

SI





9

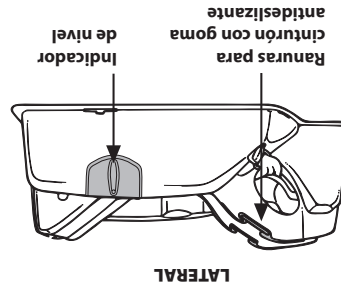
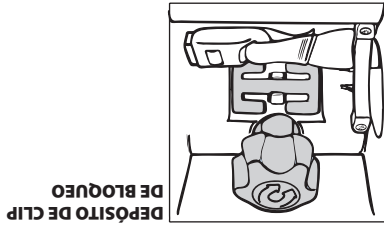
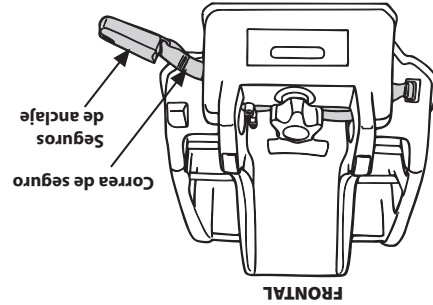
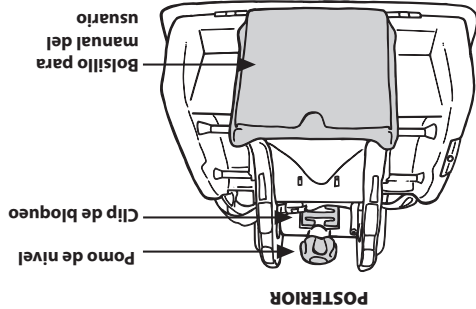

Base de la silla de auto





Silla de auto

Estructura revestida en espuma de poliestireno expandido (EPS) de absorción de impacto para una mayor resistencia al impacto.

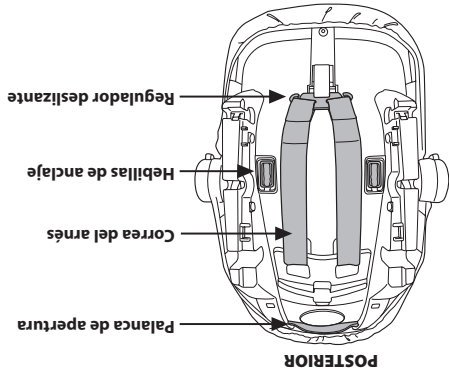

POSTERIOR

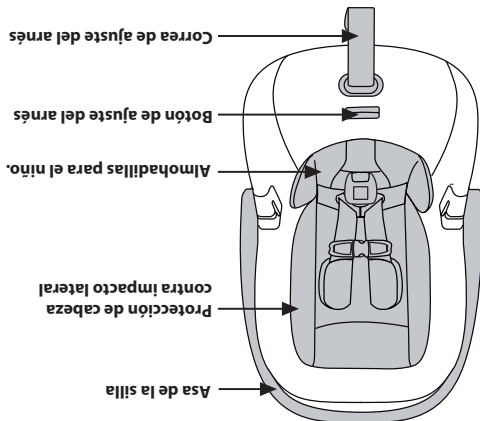
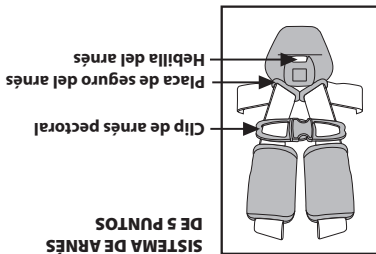

FRONTAL

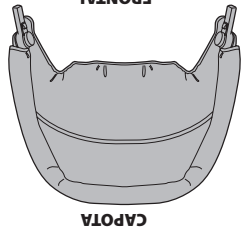



7

- No coloque la silla de auto sobre encimeras, mesas o superficies blandas.
- Nunca deje a su bebé solo en la silla de auto. Podría enredarse con las correas y sufrir heridas graves, o moverse y tumbar la silla.
- No deje la silla de auto ni la base sueltas en el vehículo, aunque no estén ocupadas. Una silla de auto suelta puede causar heridas a los pasajeros en caso de accidente.
- No utilice esta unidad pasados cinco (5) años desde la fecha de producción etiquetada en la silla.
- No cuelgue juguetes en el asa de la silla.

Reglas de seguridad

- Utilice el dispositivo sólo con niños de 5 a 30 libras (2,3 a 13,5 kg) de peso y hasta 30 pulgadas (76 cm) de estatura. Si su bebé tiene muy poco peso, pida al médico instrucciones especiales sobre cómo utilizar una silla de auto.
- Utilice esta silla de auto en vehículos con cinturones de cadera o de hombre estándar o con anclajes inferiores universales. Si su vehículo tiene anclajes inferiores, utilícelos para asegurar la silla de auto en vez de utilizar el cinturón de seguridad. Lea el manual de su vehículo para localizar los anclajes inferiores.
- Asegúrese de que la silla de auto esté nivelada correctamente. Si la silla está demasiado reclinada, su bebé podría lastimarse o ser expulsado de la silla. Si la silla está demasiado erguida, su bebé podría tener dificultades de respiración que podrían causarle heridas o muerte.



- Utilizando el arnés. Asegúrese de que las hebillas se abrochen correctamente.
- Antes de levantar la silla de la base, coloque el asa en posición de transporte.
- No acerque los dedos a las piezas móviles.
- Utilice únicamente piezas aprobadas.
- El uso de piezas no aprobadas puede comprometer la seguridad de la silla de auto y causar graves heridas o muerte en caso de accidente.
- Complete y envíe inmediatamente el formulario de registro.
- Conserve el manual junto con la silla de auto. Guárdelo en el bolsillo frontal de la base.
- En caso de accidente: si esta silla de auto sufre un accidente, podrá dejar de ser segura para el uso. Podría ser necesario adquirir una nueva unidad. Llame al servicio al cliente 1-800-671-1701 (gratuito) para más información.
- No usar Primo Viaggio SIP ES 30•30 con bases que hayan sido fabricadas antes de Julio de 2006.

- sean las instrucciones del manual de su vehículo. Según las estadísticas de accidentes automovilísticos, cuando los niños están sujetos correctamente en el asiento trasero, se encuentran más a salvo que en el asiento delantero.
- Instale esta silla de auto únicamente en asientos orientados hacia adelante. No la utilice en asientos orientados hacia atrás o hacia los costados, ni en vehículos con cinturones de hombro motorizados o montados en las puertas.
- Si utiliza un cinturón de cadera o de hombro para instalar la base, utilice un cinturón de seguridad para bloquearlo en su lugar. Si no se bloquea, utilice el clip de bloqueo. El cinturón de seguridad debe quedar bloqueado para que la silla de auto esté bien asegurada.
- Cerciórese de que la silla de auto o la base de la silla de auto quede bien asegurada utilizando un cinturón de seguridad o un seguro LATCH SYSTEM como el que muestra este manual.
- Sujete a su bebé en la silla de auto

Seguridad

⚠ Advertencia

- Esta silla de auto es conforme o supera todos los requisitos de la Norma Federal de Seguridad de Vehículos 213 para el uso en vehículos de motor y aviones.
- Su niño podría sufrir graves heridas en caso de incumplimiento de las instrucciones y etiquetas de advertencia.
- Utilice esta silla de auto únicamente orientada hacia atrás. Esta silla no está diseñada para orientarse hacia adelante. Un accidente podría causar graves heridas o muerte si la silla se instala orientada hacia adelante.
- Nunca utilice esta silla en un asiento de vehículo con airbag activo. Lea el manual de instrucciones de su vehículo para desactivar el airbag.
- Si su vehículo dispone de airbags, instalar esta silla de auto en un asiento que tenga el airbag desactivado. La activación de un



airbag puede causar graves heridas o muerte en caso de impacto contra la unidad (lea el manual de instrucciones de su vehículo para saber dónde instalar la silla de auto).

- Esta silla de auto está certificada para utilizarse con o sin base. Se recomienda utilizar la base para facilitar la instalación correcta. Instale esta silla de auto sin la base sólo en caso de necesidad.
- Nunca instale la silla de auto en el asiento delantero del vehículo salvo que tales

Servicio al cliente

Llame al servicio al cliente de Peg Perego USA, 1-800-671-1701 (gratuito) si desea obtener información sobre reparaciones o piezas de repuesto. Si alguna pieza falta o está dañada, debe ser reemplazada únicamente con una pieza Peg Perego. En la página 46 se listan las piezas de repuesto.

Si desea tener más de una base, puede adquirirla a través de su revendedor local, o llamando al 1-800-671-1701 (gratuito) o visitando www.pegperego.com.

Formulario de registro

Importante! Los dispositivos de retención para niños pueden ser reclamados para actualizaciones por motivos de seguridad. Registre este dispositivo de retención para permitir que le llamen. Envíe su nombre, su dirección, el modelo de dispositivo de retención y la fecha de fabricación a:

Peg Perego U.S.A., Inc.
3625 Independence Drive
Fort Wayne, IN 46808

O llame al 1-800-671-1701 (gratuito)

Para información sobre actualizaciones llame al número gratuito de Seguridad Auto del gobierno estadounidense 1-888-327-4236 (TTY: 1-800-424-9153). O visitar el sitio <http://www.NHTSA.gov>

Antes de empezar

- 1** Lea este manual atentamente. Conserve este manual en el bolsillo plástico de la base de la silla de auto.
- 2** Revise una a una las piezas de la silla de auto y lea las instrucciones. Lea también las etiquetas. Lea y entienda todas las instrucciones antes de utilizar esta silla de auto.
- 3** Rellene y envíe el formulario de registro (página 4).
- 4** El ensamble debe ser llevado a cabo por un adulto.
- 5** No utilice la silla de auto si falta o si está dañada alguna pieza.
- 6** Utilice sólo las piezas o accesorios que se suministran con la unidad. No modifique ni repare ninguna pieza.
- 7** Recuerde: esta silla de auto debe instalarse únicamente orientada hacia atrás.
- 8** Peg Peregó se reserva el derecho de aportar cambios al producto en cualquier momento sin aviso previo.

Tabla de contenidos

23	Instalación de la silla de auto sobre la base
25	Instalación de la silla de auto sin la base
27	Instalación de la silla con diferentes tipos de cinturones de seguridad
28	Cómo sujetar a su bebé en la silla de auto
33	Cómo levantar o bajar las correas de hombro
36	Uso de la silla de auto fuera del vehículo
39	Uso de la silla de auto en el avión sin la base
40	Uso de la silla de auto en el avión con la base
41	Limpieza y mantenimiento
42	Cómo lavar el acolchado de la silla-Desenfundable
44	Cómo lavar el acolchado de la silla-Enfundar
45	Piezas de repuesto

3 Antes de empezar

4 Servicio al cliente

4 Formulario de registro

5 Seguridad

7 Reglas de seguridad

8 Silla de auto

9 Base de la silla de auto

10 Sistema de Viaje

11 Números de Serie

12 Instrucciones de instalación

13 Instalación de la base

14 Cómo instalar la base utilizando el sistema de seguro LATCH SYSTEM

17 Cómo instalar la base utilizando los CINTURONES DE SEGURIDAD DEL VEHÍCULO

19 Instalación de la base con diferentes tipos de cinturones de seguridad

21 Cómo instalar el clip de bloqueo de seguridad

22 Diferentes tipos de cinturones de seguridad



FIU510011106

No instale ni utilice este dispositivo de retención para niños sin antes leer y entender todas las instrucciones de este manual. Para evitar heridas graves a su bebé, siga las instrucciones atentamente y asegúrese de sujetar a su bebé con el arnés de 5 puntos.

ADVERTENCIA:

MANUAL DEL USUARIO

PRIMO VIAGGIO SIP ES 30-30 Integrated Side Impact Protection

USA
Instrucciones de uso ES
(IMMI)

